

Operating and installation instructions



**GRANUDOS dosing system
45/100 PLUS-V80 Touch**
with

GRANUDOS PLUS feed system



Table of contents

1	About these instructions / general	4
1.1	Scope of applicability	4
1.2	Target group	4
1.3	Symbols used	4
1.4	Warranty	5
1.5	Further information.....	5
1.6	Information regarding support queries.....	5
2	Safety	6
2.1	Intended use.....	6
2.2	Safety notices	6
2.2.1	Handling of chemicals, risks to humans and the environment	6
2.2.2	Protective measures and rules of conduct.....	6
3	Product description – Functional description – (scope of delivery).....	8
3.1	Scope of delivery / accessories.....	8
3.2	Product description	8
3.2.1	Functioning of the GRANUDOS PLUS system.....	8
3.2.2	GRANUDOS with drum holder (standard).....	9
3.2.3	Chlorine dosing (standard).....	10
3.2.4	Acid dosing	11
3.2.5	Dissolving system	12
3.2.6	Dust extraction (optional).....	14
3.2.7	Controller (standard).....	15
3.2.8	Feed system, including buffer tank (optional).....	15
3.2.9	Individual buffer tank, with / without protection tub (optional).....	18
3.3	Identification of the device / identification plate	20
3.4	Technical data	21
3.4.1	Requirements for the calcium hypochlorite granulate	22
3.5	Transport / storage	22
4	Installation	23
4.1	Select the installation site.....	23
4.2	Installation instructions / installation suggestion	23
4.3	Mechanical installation	24
4.3.1	Installation of the GRANUDOS PLUS dosing device.....	24
4.3.2	Installation of the GRANUDOS PLUS (feed system option)	24
4.3.3	Installation of the buffer tank (buffer tank option) with protection tub	25
4.4	Hydraulic installation	26
4.4.1	Connecting the GRANUDOS PLUS dosing device.....	26
4.4.2	Connect buffer tank (optional).....	27
4.4.3	Connect feed system (optional)	27
4.5	Electric installation.....	28
4.5.1	Open and close the casing.....	28
4.5.2	Electrical connection:	29
5	Commissioning	30
5.1	Commissioning - remarks.....	30
5.2	Commissioning, setting of the operating parameters	30
5.2.1	Installation of peristaltic pump, roller carrier	30
5.2.2	Prepare acid dosing for operation.....	31
5.2.3	Attach/change the drum	32
5.2.4	Venting of the booster pump and the piping to the GRANUDOS	36
5.2.5	Initial filling of the feed system's buffer tank.....	36
5.2.6	Setting the water flow in the Dissolvin system	37
5.2.7	Setting the water level in the flushing tub	38
5.2.8	Setting the pressure switch	38
5.2.9	Venting the feed pump	38
5.2.10	Setting the pump pressure at the feed pump/pressure retention valve (optional).....	39
5.2.11	Calculating the dosing lines' flow capacity	40
5.2.12	Determining the dosing performance for the granulate dosing	40
5.2.13	Venting the pump dust extraction (Option)	42
5.2.14	Setting the dosing performance for chlorine and acid on the GRANUDOS	42

5.2.15	pH monitoring (optional).....	44
6	Operation / service.....	45
6.1	Normal filling process during operation	45
6.2	The controller - Version GRANUDOS PLUS-V80 Touch.....	45
6.2.1	Operation display – Operating status – Operation messages.....	45
6.2.2	Start –Booster pump delay and dosing delay	48
6.2.3	Operating modus - Automatic operation	49
6.2.4	Alarms.....	49
6.3	Main menu	50
6.3.1	Main menu → Login / Password	50
6.3.2	Main menu → Settings (overview).....	51
6.3.3	Main menu → Service.....	57
6.3.4	Main menu → Log (event and data logging).....	59
6.3.5	Main menu → Calibration (Optional for design with internal pH Monitoring).....	61
6.4	Calibration of external pH Monitoring (type NE).....	62
6.5	Replenish consumables.....	62
7	Maintenance, care, faults	63
7.1	Device maintenance	63
7.1.1	Clean the dirt filter	63
7.1.2	Replacing the dosing screw and the dust gasket.....	63
7.1.3	Injector with suction pipe and flow switch	66
7.1.4	Maintenance and setting of the float control valve for the flushing tub intake	67
7.1.5	Replace and set the Chlorine empty switch at the dosing hopper	67
7.1.6	Calibration of the “No chlorine switch” on the dissolve cyclone.....	68
7.1.7	Replace the dosing hose of the acid dosing pump	69
7.1.8	Cleaning the dust extraction (optional).....	70
7.2	pH measurement – calibrate pH electrode (buffer tank).....	70
7.3	Trouble-shooting.....	70
8	Decommissioning – Storage – Disposal.....	74
8.1	General	74
8.2	Decommissioning of the GRANUDOS PLUS dosing device	74
8.3	Decommissioning the feed system GRANUDOS PLUS / Buffer tank	74
8.4	Disposal of used parts and operating materials	74
9	Documents.....	75
9.1	Declaration of conformity	75
9.2	Wiring diagrams	76
9.2.1	Wiring diagram power pack with connection to the I/O circuit board	78
9.2.2	Wiring diagram for I/O circuit board GRANUDOS 45/100 PLUS.....	79
9.2.3	Wiring diagram I/O circuit board SCHW 8 – on-site buffer tank.....	80
9.2.4	Wiring diagram pH monitoring	81
9.2.5	Wiring diagram Feed system 230V FU (Pump MPN130 FU)	82
9.3	Commissioning protocol	83
9.4	Operation data sheet	84
9.5	Maintenance protocol	88
9.6	Spare part list.....	89
10	Appendices.....	90

Imprint:

All rights reserved

© Copyright by WDT – Werner Dosiertechnik GmbH & Co KG

Edition: see footer

Reproduction of any kind and translation into other languages, even in excerpts, are only permitted with the express authorisation of the company WDT - Werner Dosiertechnik GmbH & Co. KG. Subject to technical modifications
These operating instructions are an English translation of the original German version by the company WDT.

Responsible for the content:

Co. WDT - Werner Dosiertechnik GmbH & Co. KG

Hettlinger Str. 17; D-86637 Wertingen-Geratshofen

Phone: +49 (0) 82 72 / 9 86 97 – 0 Fax: +49 (0) 82 72 / 9 86 97 – 19

Email: info@werner-dosiertechnik.de

1 About these instructions / general

1.1 Scope of applicability

These instructions describe the functioning, installation, commissioning and operation of the **GRANUDOS 45/100 PLUS-V80 Touch** dosing device and the **GRANUDOS-PLUS feed system** along with the corresponding accessories.

Read these operating instructions carefully prior to operating the device and keep them in close proximity to the device for immediate use!

1.2 Target group

Only our authorised partners and people who have been trained in the device functions are permitted to work on the device.

Electrical connection work may only be carried out by appropriately trained specialists!

1.3 Symbols used

This document uses the following types of safety notices as well as general notices:



DANGER!

"DANGER" denotes a safety notice which, if disregarded, may lead to **serious** or **life-threatening injuries**, or **serious material damage!**



CAUTION!

"CAUTION" denotes a safety notice which, if disregarded, may lead to **injuries**, **damage to health** or **material damage!**



ATTENTION!

"ATTENTION" denotes a safety notice which, if disregarded, may lead to **material damage!**



CORROSIVE!

"Corrosive" denotes a safety notice which, if disregarded when handling chemicals, may lead to **injuries** or **material damage.**



ESD SENSITIVE!

"ESD SENSITIVE" denotes electronic components that may be damaged by electrostatic discharges. The generally accepted safety precautions for ESD-sensitive devices must be observed when handling the devices!



NOTICE!

A notice denotes information which, if disregarded, may lead to **malfunctions.**



Tip!

A "Tip" denotes information that may result in **improvements in the operating process.**



Mandatory sign

Use face protection!



Mandatory sign

Use protective gloves!

In accordance with DIN EN 374, protective gloves against chemicals and microorganisms.



Mandatory sign

Use protective apron!



Mandatory sign

Use protective boots!

1.4 Warranty

All WDT devices and equipment are manufactured using modern production methods and are subject to comprehensive quality control. However, should there be a reason for complaint, any compensation claims shall be directed to the company WDT in accordance with the general terms and conditions of warranty

General terms and conditions of warranty

The company WDT assumes a 2-year warranty, starting with the commissioning, up to 27 months after delivery; subject to correct installation and commissioning with a completed and signed commissioning protocol.

Exempt from this are wear parts such as gaskets, hoses, diaphragms, dosing screws, electrodes, roller carriers and other parts that are subject to mechanical or chemical wear and tear. For these we assume a warranty of 1/2 year.

Our merchandise management programme requires an invoice for each delivery (including warranty services). When returning a defective component, upon review you will receive a corresponding credit, if applicable. We request a return within 14 days.

The costs for subsequent damages and for the processing of warranty claims are excluded.

There are no warranty claims for damages caused by frost, water and electrical overvoltage or by improper handling.



Tip

Tip!

In order to protect the warranty claims, please mail the completed commissioning protocol, along with the defective component, to the company WDT. Without the commissioning protocol, we reserve the right to an exclusion of warranty.



Vorsicht!

CAUTION!

In the event of any unauthorised modifications to the device the warranty and product liability will be voided!

1.5 Further information

Additional information concerning specific topics such as, for example, designing of the dosing performance or description of the operating parameters, may be obtained from your specialist dealer, or directly from:

WDT Werner Dosiertechnik GmbH & Co KG
Hettlinger Strasse 17
86637 Wertingen/Geratshofen
Phone +49 8272 98697-0, Fax. +49 8272 98697-19
<http://www.werner-dosiertechnik.de>

1.6 Information regarding support queries

The GRANUDOS 45/100 PLUS-V80 series' control unit is subject to continued further development of both its firmware and hardware. In this, we always strive to preserve the compatibility of the components used.

For spare part orders, we require the following data. You can find these on the identification plate.

- device designation
- device serial number
- year of manufacture

In addition, we require the following data for technical support requests. These are located in the menu item **Menu → Service → Info.**

- current DSP version
- current I/O version
- current http version

2 Safety

2.1 Intended use

The **GRANUDOS 45/100 PLUS-V80 dosing device** and the **GRANUDOS PLUS feed system** may only be used for the purpose listed in the product description in chapter 3.2 *Product description!* The locally applicable regulations concerning accident prevention, occupational safety and drinking water protection must also be observed in this regard!

2.2 Safety notices

Carefully read and comply with the operating instructions prior to installation and use of the device! Work on the device and changes in the settings may only be carried out by properly instructed persons!



IT safety

The GRANUDOS 45/100 PLUS-V80 control unit makes remote display possible using network-enabled devices. The operator is responsible for ensuring that only authorised persons can access the device. The operator, or his authorised representative, is further responsible for the safety of all Internet and/or WLAN connections.

2.2.1 Handling of chemicals, risks to humans and the environment

In case of emergencies when handling chemicals, contact the emergency poison centre!

Emergency number:

112 for the local emergency medical services or

Munich Emergency Poison Centre Phone: 0049 89 19240 or

or see "Safety data sheet" of the chemical

2.2.2 Protective measures and rules of conduct



DANGER! CORROSIVE! SAFETY EQUIPMENT!

The **GRANUDOS PLUS** dosing system doses both the calcium hypochlorite granulate and the pH reducer (acid) from the delivery container.

These substances have a strong reaction when combined and release toxic chlorine gas outside of water. For this reason, the greatest possible care must be taken when working with chemicals and it is essential that personal safety equipment is worn: Face protection, protective gloves, protective apron, boots.



The chlorine granulate and the acid must not be mixed with each other or with other chemicals or substances!



Store chemicals so that they are not accessible to unauthorised persons.

When storing chemicals, the chemicals manufacturer's safety data sheets must be complied with.



For more information, see the chemical manufacturer's safety data sheets!



CAUTION!

If water from the drinking water network is used to supply the **GRANUDOS PLUS** dosing device, for the protection of the water network a system separation must be installed according to the locally applicable legal provisions (for Germany and the

EU: DIN EN 1717: 2011-08). This prevents a backflow of the water contaminated with chemicals in the event of a sudden pressure drop in the network!



ATTENTION! ESD SENSITIVE!

The electronic components in the device controls are sensitive to electrostatic discharge. For this reason, the generally accepted safety precautions for ESD-sensitive devices must be observed when handling the devices, including:

- Discharge of personal static charge
- Dissipative clothing
- Disconnect the device from the voltage supply

3 Product description – Functional description – (scope of delivery)

3.1 Scope of delivery / accessories

The “GRANUDOS 45/100 PLUS-V80 TOUCH” dosing system comprises the following components:

- Standing column with a rotatable drum holder
- Dosing device for chlorine granulate
- Dosing device for acid
- Dissolving system
- Controller with 7” touch colour display

The following options are available

1. **Feed system** for distributing the chlorine solution among several basin cycles; this consists of:
 - a) Buffer tank, including a protection tub, integrated in the feed system
 - b) Feed works with pump and piping
 - c) Distribution system / dosing lines for the chlorine solution. (Number freely selectable)
2. **Buffer tank** with or without protection tub
3. **pH Monitoring** to check the pH value
4. **Dust extraction** for granulates containing dust
5. **Remote display and remote access**
6. **Lifting device**

3.2 Product description

Dosing system for the disinfection of swimming pool water with calcium hypochlorite. This is particularly well-suited for multi-basin systems.

3.2.1 Functioning of the GRANUDOS PLUS system

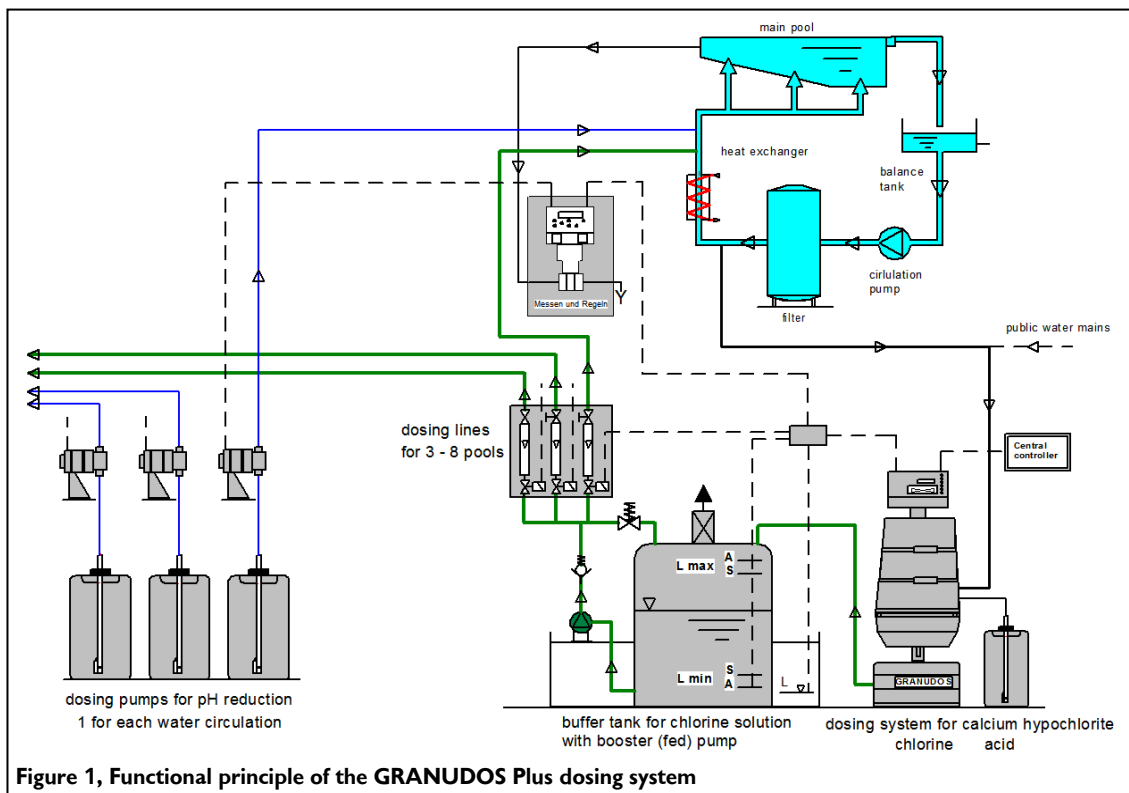

The **GRANUDOS PLUS** dosing device uses calcium hypochlorite granulate with water and acid to prepare a pH-neutral, very low-concentrated chlorine solution (maximum 0.35% chlorine) for the disinfection of swimming pool water. The chlorine granulate and the acid needed for neutralisation are dosed in turns with intermittent pauses into the Dissolving system, which is subject to a continuous flow of water. The dosed chemicals are completely dissolved and fed into the feed system’s buffer tank via an injector system.

3.2.2 GRANUDOS with drum holder (standard)

A rotatable drum holder is mounted on the stable standing column. The chlorine drum (14) is set on this drum holder and strapped to the rear wall with 2 tension bands (02); for this, the drum is held by a cross bar at the reinforced grip edge. The safety belt (03) is closed with the clamping lever (05), additionally securing the drum in the turning device. After rotating the drum holder with the clamped-on drum, the drum is in the dosing position. The spring bolt (09) is used to lock the drum holder in the drum change or dosing position. The acid pump (10) for dosing the pH reducer and the dirt filter for the Dissolving system's booster pump are installed on the standing column.

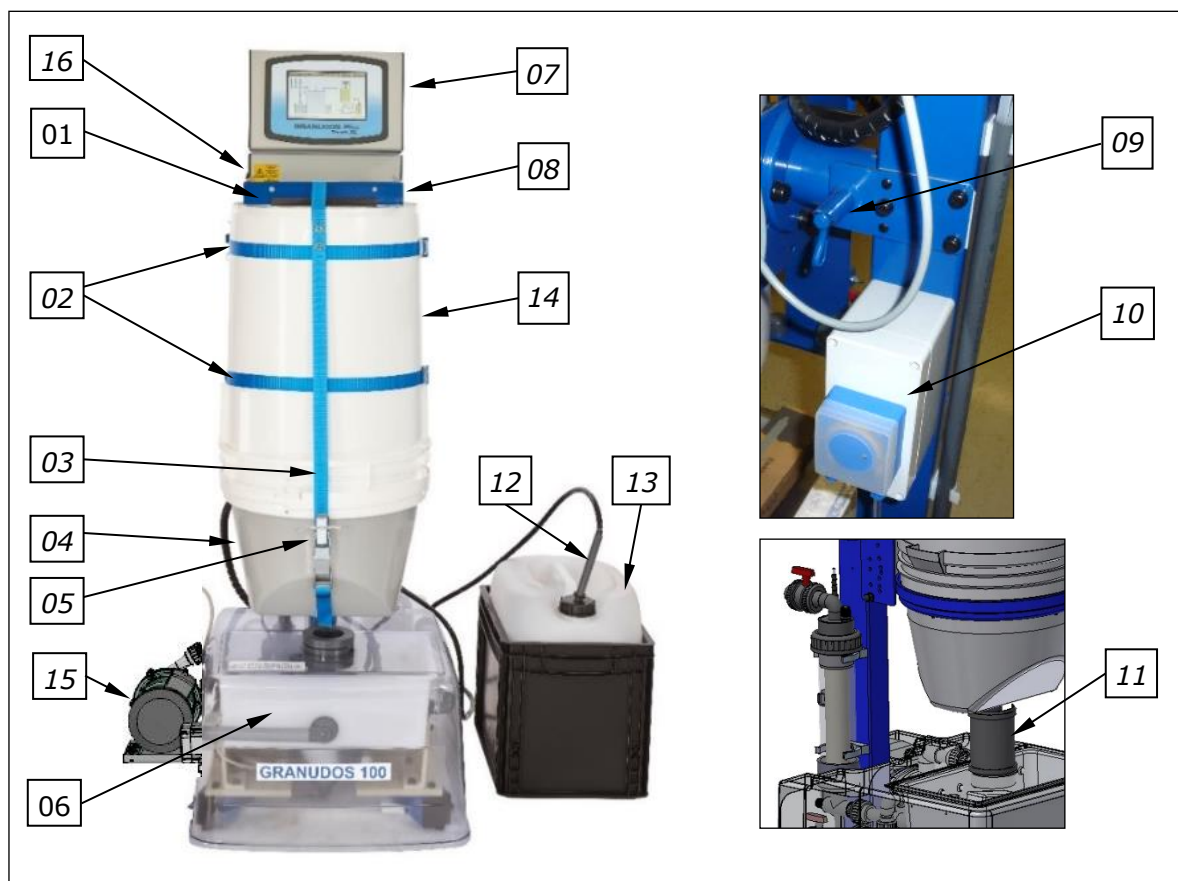

Figure 2, GRANUDOS PLUS with dust extraction

- | | |
|--|--|
| 01. Drum holder | 09. Spring bolt for the turning device |
| 02. Tension bands | 10. Acid pump (covered) |
| 03. Safety belt | 11. Dust protection, protective pipe |
| 04. Dosing head | 12. Suction lance for acid |
| 05. Clamping lever for the safety belt | 13. Acid canister with protection tub |
| 06. Dissolving system | 14. Chlorine drum |
| 07. Controller | 15. Dust extraction |
| 08. Identification plate (on the right side of the upright pipe) | 16. Main switch (lateral) |

3.2.3 Chlorine dosing (standard)

The illustrated dosing head is screwed on the chlorine drum. It is used for dosing the chlorine granulate into the Dissolving system.

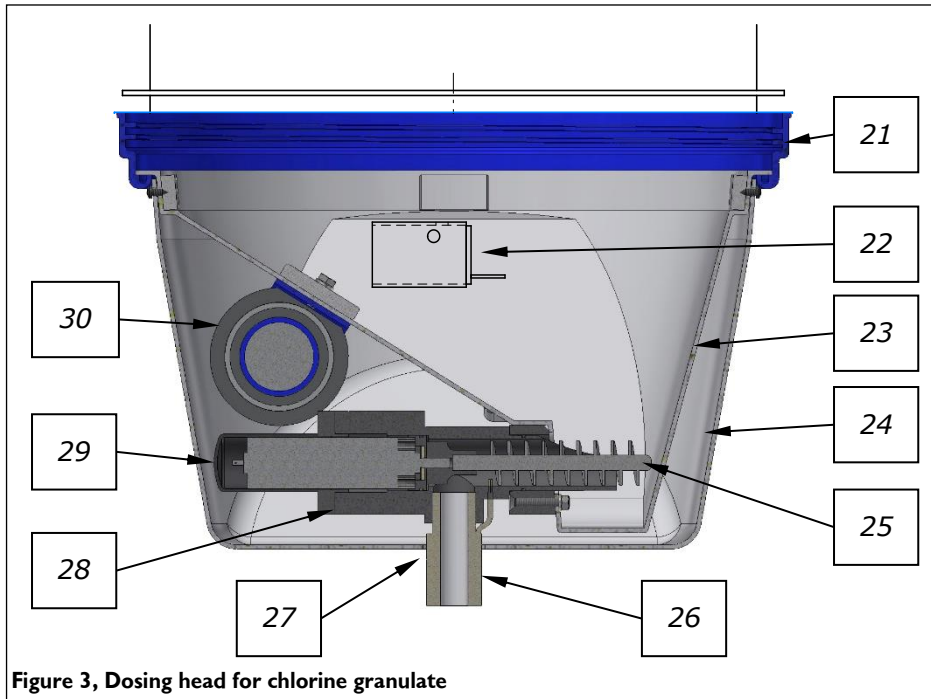

Figure 3, Dosing head for chlorine granulate

- | | |
|-----------------------------------|-----------------------------------|
| 21. Screw ring (with drum thread) | 26. Dosing pipe, heated |
| 22. Chlorine empty switch | 27. Sealing washer |
| 23. Dosing hopper | 28. Motor bracket with screw tube |
| 24. Protective cover | 29. Dosing motor |
| 25. Dosing screw | 30. Solenoid knocker |



The dosing device consists of the dosing hopper (23) with cover (24), installed on the chlorine drum, and the dosing unit. The dosing unit consists of:

- The dosing motor with flange (29), the dosing screw (25),
- the motor bracket (28)
- the heated dosing pipe (26)

The heating of the dosing pipe prevents the condensation of water vapour, which could lead to a dosing blockage.

The dosing screw (25) transports the calcium hypochlorite granulate from the Dosing hopper (23) into the Flushing pipe (44) of the underlying Dissolving system. A Solenoid knocker (30) is installed for breaking up the chlorine granulate; during each dosing process, the solenoid knocker delivers a short knock to the dosing hopper, thus preventing the granulate from bridging across the dosing screw.

The chlorine dosing is organized in alternating cycles with the acid and is monitored (see *Chapter 3.2.6, Controller*). The drum's chlorine content is continuously calculated by the controller, and a "Reserve

indication"  appears on the display if the set dosing amount has been exceeded. The granulate fill level is shown on the display. Once the "Chlorine empty switch" (22) triggers, the display shows the "Chlorine empty" notification  and the dosing is stopped.

The dosing performance is set in **Main menu → Settings**. It must be selected at a level high enough to ensure that sufficient chlorine solution is available even if it is requested for all basins. **A dosing setting below 50% is not possible!**

3.2.4 Acid dosing

The acid dosing in the GRANUDOS PLUS is used to completely dissolve the chlorine granulate and to neutralise the chlorine solution: a weakly concentrated, neutral hypochlorous acid is generated. For this purpose, a peristaltic pump is installed as standard. During commissioning, the acid dosing must be coordinated with the chlorine dosing so that the chlorine solution in the buffer tank has a pH value between 6.8 and 7.2. The correct dosing ratio is set after measuring the chlorine solution's pH value. In that case, the calcium hypochlorite solution is completely dissolved. The solution is practically clear and lacks a strong chlorine smell. If the pH value is too low, the solution has a strong chlorine smell and acts more corrosive. If the pH value is too high, the solution is cloudy and precipitation/deposits form in the buffer tank and in the dosing lines.

The peristaltic pump sucks the acid from an acid canister. The filling level in the acid canister is continuously calculated and a "Reserve indication"



appears on the display if the set dosing amount has been exceeded. The acid fill level is shown on the display. Once the "Acid empty switch"



triggers, the dosing is switched off; otherwise, the generation of hypochlorous acid is no longer guaranteed.

As with the chlorine, the dosing performance is entered in the menu item **Menu → Settings**. 37-50% sulphuric acid is recommended as acid.



Tip!

In special cases, e.g., if the water is very hard and/or has a high pH value and/or a high dosing performance is required, it is recommended to use hydrochloric acid instead of sulphuric acid. This prevents the potential formation of gypsum residue due to high sulphate concentrations in the buffer tank (optional).



CAUTION!

With a hydrochloric acid concentration of more than 10%, a Viton hose must be inserted in the peristaltic pump! This hose must be replaced every 6 months!

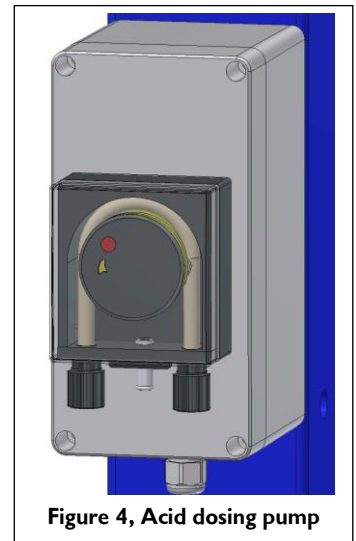
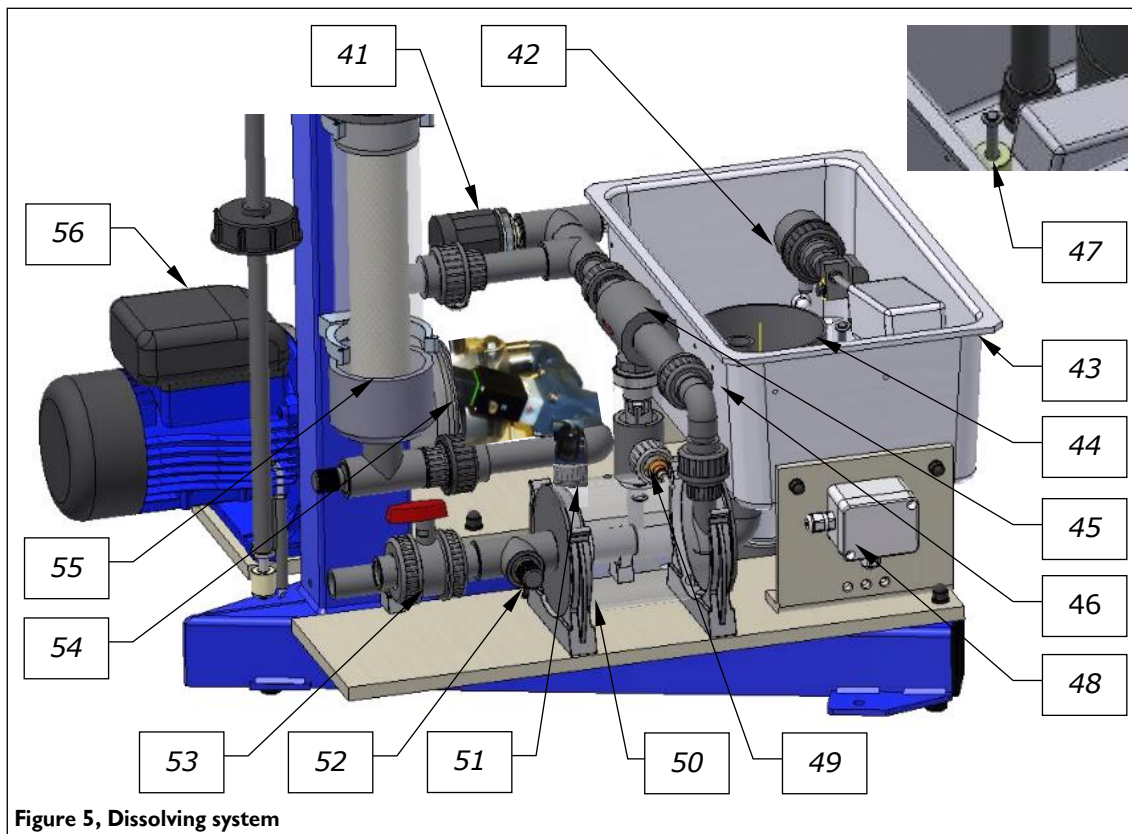

Figure 4, Acid dosing pump

3.2.5 Dissolving system



- | | |
|---|--|
| 41. Pressure switch | 51. No chlorine switch / sensor on the cyclone |
| 42. Float control valve at flushing tub intake with float | 52. Connection for manometer |
| 43. Flushing tub | 53. Outflow ball valve |
| 44. Flushing pipe | 54. Control valve for the dissolving water |
| 45. Injector | 55. Dirt filter d75 mm |
| 46. Screw connection with hole washer | 56. Booster pump (various designs) |
| 47. Level switch min. /max. Flushing tub | |
| 48. Connection socket for the switches | |
| 49. Flow switch for flushing tub | |
| 50. Dissolving cyclone | |

Dosing the chlorine solution causes the level in the buffer tank to drop. Once the starting level has been reached in the buffer tank, the *Control valve for the dissolving water* (54) opens and the booster pump starts. The dissolving water is separated downstream of the booster pump (56): A partial flow is directed into the flushing tub (43) via the float control valve (42). From there, it is suctioned off by the injector (45), together with the additional chemicals dosed in the flushing pipe (44). The calcium hypochlorite granulate is kept in circulation in the dissolving cyclone (50) until it has been completely dissolved by the water and the acid. An optical sensor (51) records the dosed chlorine granulate, which can be seen in the cyclone shortly after the dosing has started. If no chlorine is recorded 8 seconds after the start of the second dosing cycle, the dosing is stopped and the controller reports the fault.

Changes in the Dissolving system's water supply that cause the Dissolving system to no longer operate properly are recorded by the level switch (47), the flow switch (49) and the pressure switch (41). In these cases, the dosing of chemicals and also the booster pump, if applicable, will be turned off to prevent potential subsequent damage.

The pressure switch (41) is installed in the booster pump's pressure line. It switches off the GRANUDOS in case of a pressure drop, e.g., during an intake of air, to prevent the pump from running dry. In addition, a monitoring switch or a contact from the central unit can be connected to switch off the filling in the event of a fault in the filter system, e.g., no flow in the clean water line.

The flow switch (49) installed in the injector's (45) suction line is of essential importance for the GRANUDOS' operational safety. If the suction capacity (minimum 150 l/h) is too low, the switch body that has been pushed upward by the upward flow in the suction pipe drops and the chemical dosing is turned off. This ensures that dosing only occurs in vigorously flowing water and the two chemicals **cannot** meet in the open area.

At the same time, the *Control valve for the dissolving water* (54) blocks the intake to the flushing tub in the event of a downtime or malfunction of the device.

The flushing tub overflow (43) conducts the - chlorine-free - excess water that occurs in case of the "Water max" fault to the duct.

To prevent the chlorine granulate and the acid from mixing and reacting with each other in the Dissolving system's open part, the following safety package has been installed:

- The dosing of the two chemicals, chlorine granulate and acid, occurs in set cycles with pauses between the dosing processes. The power supply of the two dosing motors is locked via a relay system in such a way that **both motors can never be running at the same time!**
- The water supply and water flow are monitored by the pressure switch (41), level switch (47) and flow switch (49).
- Dosing only takes place when the water flow is ensured.
- In the event of any deviation from the set target values, the dosing system is turned off and a corresponding fault indication is generated.



ATTENTION!

The use of sulphuric acid is generally possible up to a concentration of 50%. For higher concentrations or when using other acids (e.g., hydrochloric acid), the changed dosing performance and/or increased corrosiveness must be taken into account! We recommend consultation with the manufacturer!

3.2.6 Dust extraction (optional)

The dust extraction serves to reduce the intrusion of dust in the vicinity of the device. The use of granulates with an increased dust content may lead to a minor dust discharge at the device. This will subsequently settle on the protective cover. The dust extraction is based on the water jet nozzle (injector) principle

The flushing of the dust extraction serves for the automatic cleaning of the flushing pipe and the dust extraction's injector. During operation, it is possible that **the chlorine dosing and the flushing are active simultaneously**. This constitutes a **normal operating state**.

The flushing interval is controlled via a relay. This is pre-set ex works to 10s flushing and 1h pause. To change the parameters, see Chapter 6.3.2.5, Main menu → Settings → Dust extraction (optional).

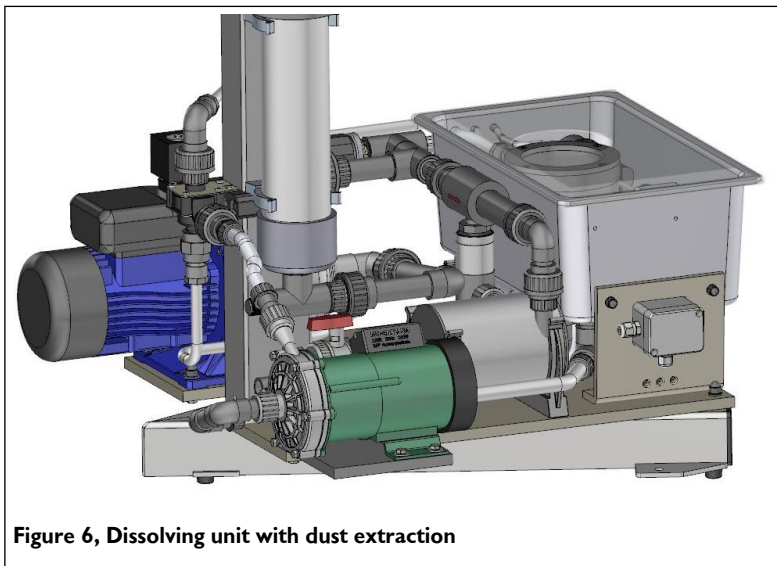
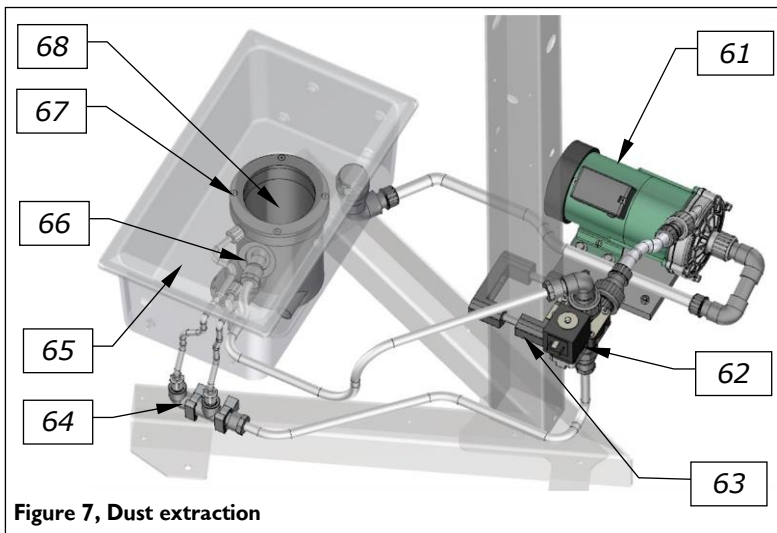

Figure 6, Dissolving unit with dust extraction



- 61. Solenoid-coupled circulation pump
- 62. Solenoid valve
- 63. Pipe clamp
- 64. Flushing water distributor
- 65. Flushing tub lid (transparent)
- 66. Injector
- 67. Flushing ring assembly
- 68. Flushing pipe / Dust extraction swirler assembly

Figure 7, Dust extraction

3.2.7 Controller (standard)

Controller (version GRANUDOS PLUS-V80 Touch)

The controller is contained in a dust- and splash-proof housing (protection class IP 54). External switches and remote fault indications are connected in the lower housing part.

The controller of the GRANUDOS PLUS-V80 dosing system is simple and easy to operate using a 7" touch display.

The operating states and faults are displayed directly via the function display as an active flow diagram. For a detailed description, see Chapter 6. Operation.

The start display:

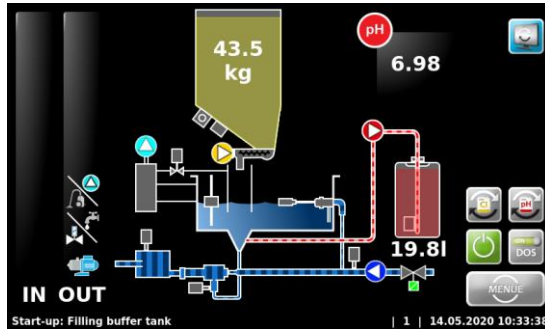

Figure 8, Start display

3.2.8 Feed system, including buffer tank (optional)

The GRANUDOS PLUS feed system is used to distribute the pH-neutral chlorine solution produced by the GRANUDOS PLUS dosing device to the individual basin cycles. Via the pressure retention valve, the feed pump generates an even inlet pressure for the dosing lines' supply, irrespective of the number of opened dosing lines. This ensures the same flow rate, i.e., the same chlorine dosing performance, each time the control valves are opened.

As standard, the feed system consists of:

- a 300l buffer tank, including protection tub
- solenoid centrifugal pump with PVDF head and piping, and
- a distribution system / dosing lines for the chlorine solution.

Optional accessories:

- pH Monitoring



Figure 9, Feed system

Re a) Buffer tank integrated in the feed system

The buffer tank with a 300l capacity has an integrated quadruple level switch. The buffer tank filling exclusively occurs via these level switches

See also *Figure 14, Buffer tank without protection tub, Chapter 3.2.9.*



Figure 10, Integrated buffer tank, rear view

Re b) Feed pump with piping

The solenoid-coupled feed pump (75) with PVDF head is resistant against the corrosive chlorine solution.

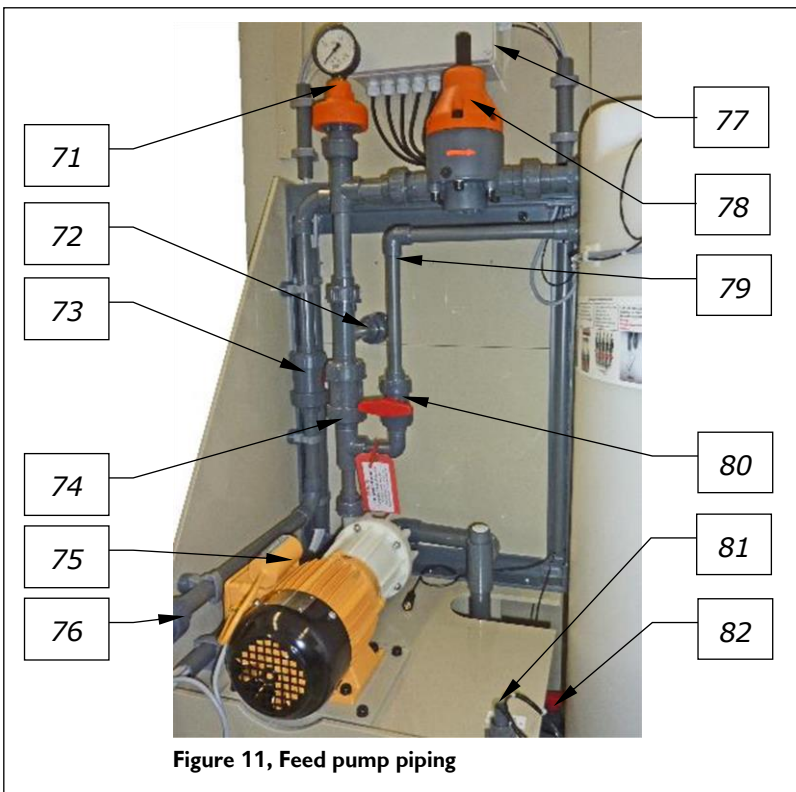

Figure 11, Feed pump piping

- | | |
|--|--|
| 71. Diaphragm seal with manometer | 77. Terminal box for connecting the control valves |
| 72. T-piece to the distributor plate | 78. Pressure retention valve |
| 73. Non-return valve in the filling line | 79. Vent line for the feed pump |
| 74. Non-return valve on the feed pump | 80. Ball valve for venting |
| 75. Feed pump | 81. Alarm switch for the protection tub |
| 76. Filling the GRANUDOS | 82. Buffer tank suction line with ball valve |

3 feed pumps with and without frequency converter are available for different pressure situations in the treatment technology (see *Chapter 3.4, Technical data*).

Re c) Distribution system / dosing lines for the chlorine solution

The entire distribution system for the chlorine solution is installed on the feed system and fully preassembled.

The dosing lines consist of the following components:

91. Membrane valves or dosing ball valves for setting the required flow capacity or dosing performance
92. Flow meter to illustrate the flow capacity
93. External pH monitoring (optional)
94. Solenoid valves, controlled by the measuring and control technology, for free chlorine
95. Shut-off ball valves
96. Screw connection from the feed pump

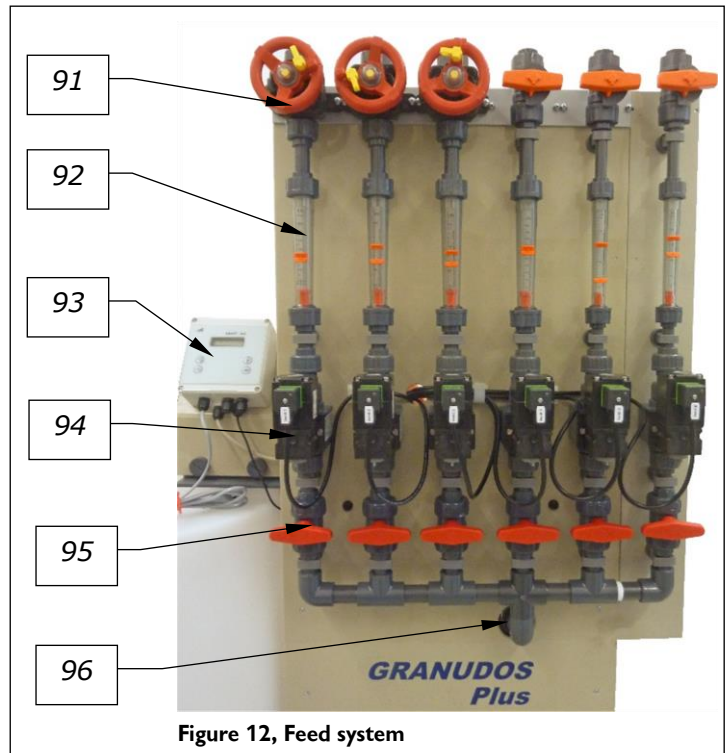

The required flow capacity is determined based on the solution's chlorine concentration and the required dosing performance of free chlorine. See *Chapter 5.2.120, Determining the dosing performance for the granulate dosing*

In the event of a fault, a relay system interrupts the power supply for the control valves if the feed pump is switched off due to a fault indication in the GRANUDOS system. This causes the control valves to close.



ATTENTION!

As additional protection against back-flowing water, non-return ball valves must be installed in the dosing lines on-site!

Re d) pH monitoring (optional)

If the chlorine dosing fails during the filling of the buffer tank, an acidic chlorine solution is produced due to the consistently set acid dosing. This acidic chlorine solution would then be dosed by the measuring and control technology when chlorine is requested, leading to a drop of the pH value in the basin. To prevent this, the chlorine solution's pH value is measured. If the pH value no longer meets the set target range, the filling is stopped and an alarm is indicated.

- 101. Ball valve for venting
- 102. pH electrode
- 103. Adapter PG13.5 for the pH electrode
- 104. Feed pump head
- 105. Connection to the suction piping in the buffer tank

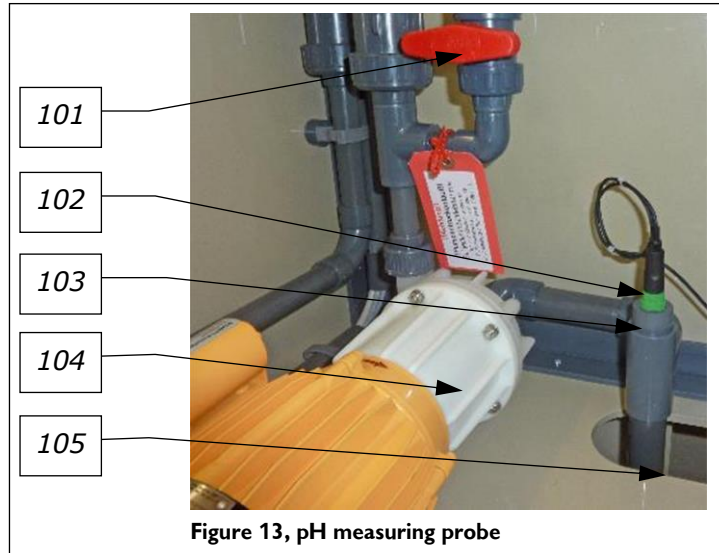

Figure 13, pH measuring probe

- The pH electrode is directly connected to the GRANUDOS' controller.
- The pH electrode's cable must be installed in a separate protective pipe at a distance of no less than 10 cm from live cables.
- If the feed system is located more than 10 m away from the dosing device, the external pH monitoring should be installed directly on the feed system. (An excessively long electrode cable could transmit fault impulses to the controller).

Length of electrode cable:

- Standard 5 m
- Optional 10 m

3.2.9 Individual buffer tank, with / without protection tub (optional)

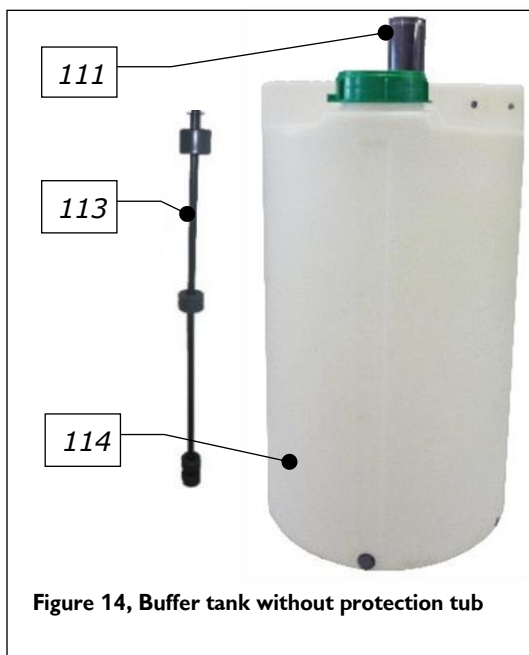

Figure 14, Buffer tank without protection tub

- 111. Activated carbon filter
- 112. Protection tub PP (not shown)
- 113. Quadruple level switch, from bottom to top:
 - Buffer tank minimum level alarm
 - "Start filling" level
 - "Stop filling" level
 - Maximum level alarm
- 114. Buffer tank 300 l PE

Filling procedure

- When the buffer tank's lower control level "Start filling" is reached, the GRANUDOS PLUS starts filling the buffer tank.
- At the buffer tank's upper control level "Stop filling" the filling is stopped; it is then followed by a flushing cycle to clean the Dissolving system: initially for 20 seconds with acid, followed by 20 seconds with water only.
- At the buffer tank level "minimum alarm", the feed pump is switched off and an alarm message is shown on the display; the alarm output is active.
- At the buffer tank level "maximum alarm", an alarm message is shown on the display. The feed pump continues to run to prevent a potential backflow from the dosing line.

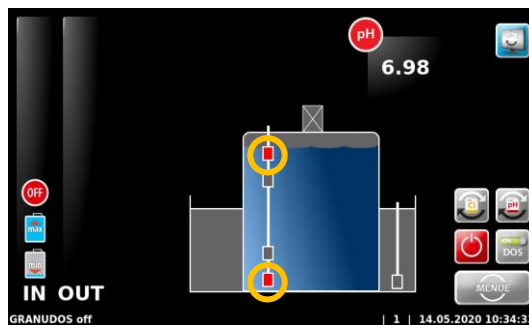

Figure 15, Fault indication minimum alarm and maximum level alarm at the buffer tank

Contact positions

When the container is half full, the level switches' contacts are set as follows:

<u>Level position</u>	<u>Contact</u>
Minimum level alarm	open
"Start filling" level	open
"Stop filling" level	open
Maximum level alarm	closed

An activated carbon filter (111) is screwed on the buffer tank. It is used to clean the chlorine-containing air when filling the buffer tank and for venting during draining.

The buffer tank is located in the protection tub (112, not shown). If the level switch (47) in the protection tub indicates a fault, the following errors are possible:

- There is a leakage at the buffer tank or in the piping.
- The upper level switch in the buffer tank to stop the filling **and** the "Maximum level" alarm are not working.
- Backflow from a dosing line out of the swimming pool when the feed pump is switched off, non-closing solenoid valve **and** leaking non-return valve.

In each case, the GRANUDOS dosing device switches off, the feed pump continues to run or restarts to prevent an overflow of the protection tub in the cases b) and c).



ATTENTION!

The switch in the basin must be checked once per year! – See maintenance protocol.

3.3 Identification of the device / identification plate

Identification plate for GRANUDO PLUS-V80 Touch

Enter the data from the identification plate of your device here.

Typ: GR <input type="text"/> Plus/V80T/ <input type="text"/> Art.: <input type="text"/> Serien Nr.: <input type="text"/> 230V/AC 1Ph~ 50Hz Imax. <input type="text"/> A Dosierleistung 2kg/h-2l/h CI/Ph Herstellung: <input type="text"/>  WDT - Werner Dosiertechnik GmbH & Co. KG Hettlinger Str. 17 D-86637-Wertingen

Field 1: Complete the type identification

Field 2: Enter drum type

Field 3: Article no.:

Field 4: Serial no.:

Field 5: Enter current rating

Field 6: Enter date of manufacturing

Identification plate for GRANUDOS PLUS feed system

Enter the data from the identification plate of your device here.

Typ: Förderanl.GRANUDOS Plus <input type="text"/> Art.: <input type="text"/> Serien Nr.: <input type="text"/> <input type="text"/> V/AC <input type="text"/> Ph~ 50Hz Imax. <input type="text"/> Pufferbehälter 300 Liter Herstellung <input type="text"/>  WDT - Werner Dosiertechnik GmbH & Co. KG Hettlinger Str. 17 D-86637-Wertingen
--

Field 1: Complete the type identification

Field 2: Enter article number

Field 3: Serial no. Enter serial number

Field 4: Enter supply voltage in volt

Field 5: Enter number of phases (ph)

Field 6: Enter maximum current rating

in ampere

Field 7: Enter date of manufacturing

3.4 Technical data

	GRANUDOS PLUS 45/100 V80	GRANUDOS PLUS feed system
Dimensions and weights:		
Dimensions	W 60 cm, D 70 cm, H 140 cm	W 120cm, D 80cm, H 200cm
Device space requirement (base)	W 130 cm, D 90 cm	W 120cm, D 90 cm
Space requirement, including operation and maintenance	W 130 cm, D 170cm	W 120cm, D 170cm
Empty weight / operating weight	approx. 50kg / 100kg	approx. 70kg / 370kg
Connection data		
Electric connection data	230VAC/50Hz ± 10%, 350W, I max. 3.15A, safety plug	230VAC, 50Hz, 0.55kW 400VAC, 50Hz, 1.1kW
Fuse front panel	Fine wire fuse 6.3A slow	
Hydraulic connection data	Intake DN20 Outlet DN20	Intake DN20 Outlets DN15
Required duct connection	At least DN25	
Protection class	IP54	IP54
Operating pressure Required inlet pressure Counter-pressure	max. 2.5 barg min. 0.2 barg 0 - 1.4 barg (depending on inlet pressure)	max. 1.7 barg
Dissolving water supply	From the swimming pool water cycle <u>with booster pump (b-pump):</u> 0.3 kW, 230VAC at least 0.2 barg <u>With tap water without b-pump:</u> at least. 3 .0 barg (EU: System separation required!)	
Operating data:		
Dosing performance GR 45	Chlorine: 1 - 2 kg/h ⁽¹⁾ Acid: max. 3 l/h	
Dosing performance GR 100	Chlorine: 2-4 kg/h ⁽¹⁾ Acid: max. 3 l/h	
Sum of the set water flow of all dosing lines		max. 1200l/h
Filling capacity of the dosing device	max. 1200l/h	
Booster pump	0.39kW, 230V, 1.95A	
Feed pump		up to 1barg: 0.55 kW, 230VAC, 50 Hz, 1 Ph up to 1.7 bar: 1.1 kW, 230VAC, 50 Hz, 1Ph with FU up to 1.5 barg: 1.1 kW, 400VAC, 3Ph ⁽³⁾
Medium temperature Ambient temperature Humidity technical room	5°C to 35°C 5°C to 35°C max.: 70% (non-condensing)	5°C to 35°C 5°C to 35°C max.: 70% (non-condensing)
Concentration hypochlorous acid	Granudos 45: max. 0.2% Granudos 100: max. 0.35%	
Room ventilation (in and out)	According to the locally applicable provisions, e.g., DIN 19643 – BGR-108 in Germany	
Material	Standing column: Steel, galvanised and painted Other functioning parts: PVC , PE Gaskets: EPDM, Viton	PVC or PE, PP Gaskets: Viton

Footnotes regarding the technical data

- 1) The dosing performance for the chlorine granulate depends on the type of granulate: In case of a high dust content in the granulate or with very coarse materials > 3 mm, the dosing performance may be significantly reduced. See specification in *Chapter 3.4.1*.
- 2) A separate electric supply with 400VAC, 3ph is required.

3.4.1 Requirements for the calcium hypochlorite granulate

Based on over 30 years of experience with the dosing of calcium hypochlorite granulate it is apparent that the quality of the granulate has a significant impact on the dosing's functional safety. Here, we define our minimum requirements for the calcium hypochlorite granulate. If these quality criteria are met, a proper dosing operation can be assumed in this regard.

The following can be checked upon receiving the granulate to gain an initial impression of the quality:

- The granulate must be white.
- Free of clumps.
- No strong chlorine smell must be present when opening the drum.

Specification:

- Calcium hypochlorite concentration: → higher than 70 %
- Water-insoluble (Ca(OH)₂, CaCO₃): → less than 4 %
- Humidity: → less than 5%

Grain size:

- Dust: → smaller than 0.15 mm (100 mesh) → smaller than 1%
- Fraction of coarse particles: → larger than 2.5 mm (8 mesh) → smaller than 5%

3.5 Transport / storage

Please check the devices immediately upon receipt for potential transport damage.



ATTENTION!

The systems and devices can be damaged by frost or high temperatures. Do not store systems and devices next to objects with strong heat emission or in direct sunlight. The device may only be transported and stored in its original packaging. Please ensure careful handling.

Storage of chemicals



DANGER!

**Observe the chemicals suppliers' safety data sheets!
In addition, please observe the provision regarding the storage of chemicals TRGS 515.**

General

- Store chlorine dry and cool
- Keep a chlorine supply at hand for less than 6 months

4 Installation

4.1 Select the installation site

The following should be observed in regard to the installation site:

- A freely accessible installation location should be selected to facilitate operations and subsequent maintenance tasks.
- Comply with the dimensions for the floor drain and the temperature specifications for the ambient air and medium in accordance with *Chapter 3.4 Technical data*. No flammable vapours, dust or gases may be present in the immediate vicinity of the device.
- The device must not be exposed to the elements. It may not be installed outdoors. The device must be protected from frost and direct sunlight.
- An electricity grid connection and a duct connection must be available.
- The installation site must comply with the local accident prevention regulations and should not be accessible to unauthorised persons. A separate storage space must be available for the chemicals.
- It must be possible to vent and aerate technical areas so that hazardous substances do not occur in health-hazardous concentrations (from accident prevention regulations). A strong air current at the dosing device must be avoided.
- Protection tubs must be available for the chemical canisters and the buffer tank, if applicable.

4.2 Installation instructions / installation suggestion

- Remove transport safety devices
- Attach warning and notice signs in accordance with the locally applicable accident prevention regulations at the designated positions.

Suggested installation:

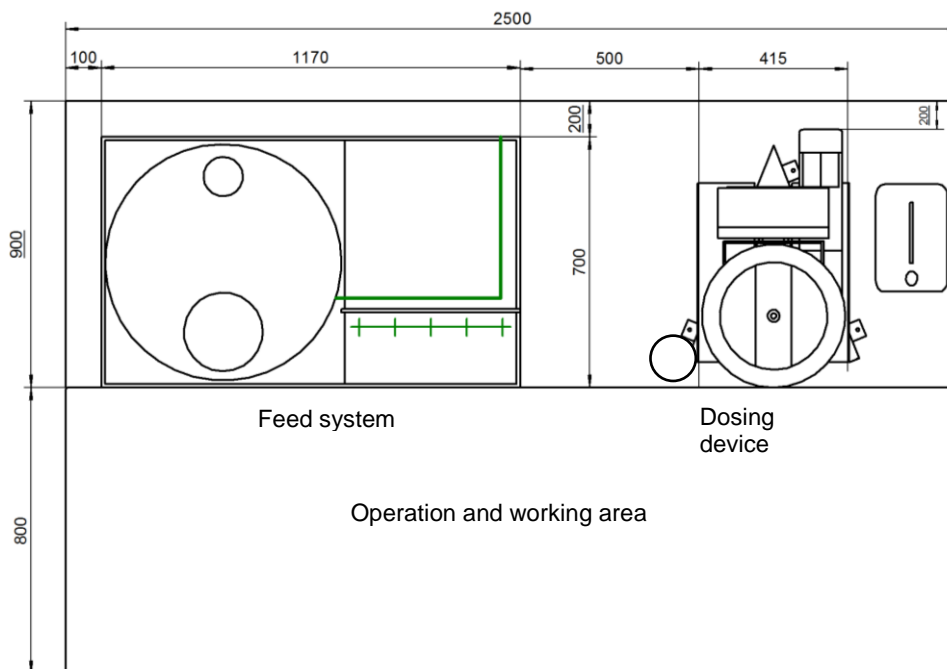

Figure 16, Suggested installation, including space requirements

4.3 Mechanical installation

The dosing device is delivered completely pre-assembled with the controller and the dirt filter.

4.3.1 Installation of the GRANUDOS PLUS dosing device

Place and align the GRANUDOS PLUS dosing device on a suitable, level foundation in the technical room.

Ensure that there is sufficient clearance for operating and servicing the device.



ATTENTION!

Once the installation has been completed, attach the GRANUDOS PLUS to the floor, using the 3 enclosed screws!

Installation materials

Spare part bag with manometer, gaskets, membranes



Maintenance set for dosing motor



Accessories for acid pump



4.3.2 Installation of the GRANUDOS PLUS (feed system option)

The feed system should preferably be set up to the left of the dosing device (see suggested installation). If a different positioning is required, or if the feed system is located on a different height level than the dosing device, the manufacturer should be consulted prior to installation.

Place and align the feed system on a suitable, level foundation in the technical room.

Ensure that there is sufficient clearance for operating and servicing the device!

Feed system:

- 121. Distributor plate with dosing lines
- 122. Mounting plate
- 123. Screw connection to the feed pump
- 124. Diaphragm seal with manometer
- 125. Carry handle

Procedure:

The distributor plate was dismantled for transport.

- a) Place the distributor plate (121) on the mounting plate (122) and screw it to the frame.
- b) Connect the screw connection (123) to the feed pump behind the mounting plate.
- c) Screw the diaphragm seal (124) together with the pre-installed manometer into the T-piece.
- d) The 4 carry handles (125) at the corners of the protection tub may be cut off.

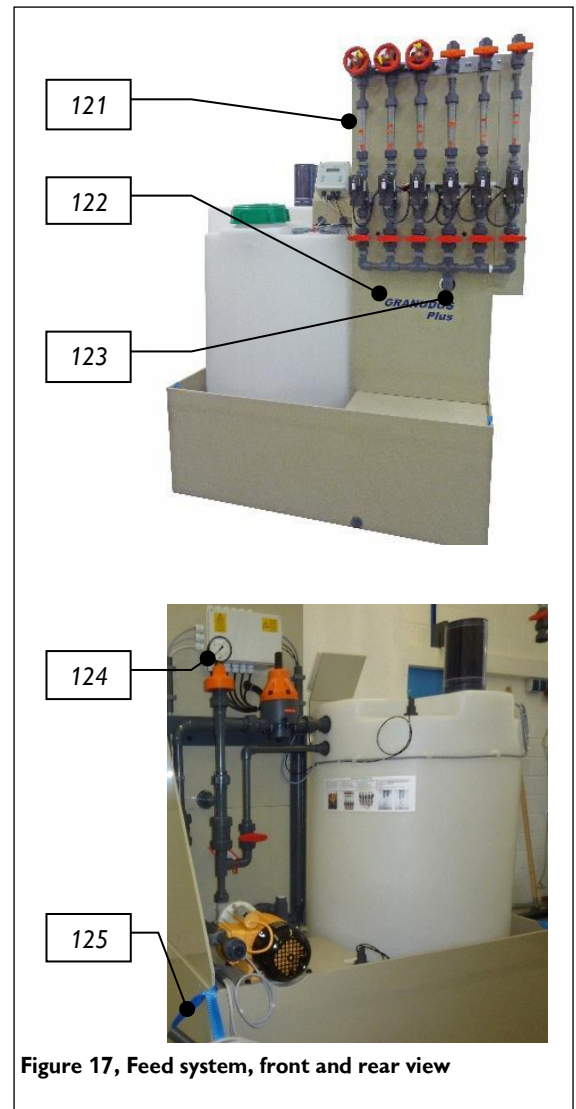

Figure 17, Feed system, front and rear view

4.3.3 Installation of the buffer tank (buffer tank option) with protection tub

- The buffer tank may only be operated with a suitable protection tub. (On-site protection tub, if necessary.)
- Place and align the protection tub on a suitable, level foundation in the technical room.
- Place the empty buffer tank in the protection tub and check for secure footing.
- Ensure that there is sufficient clearance for operating and servicing the device.

4.4 Hydraulic installation

4.4.1 Connecting the GRANUDOS PLUS dosing device

Integration into the water circulation:

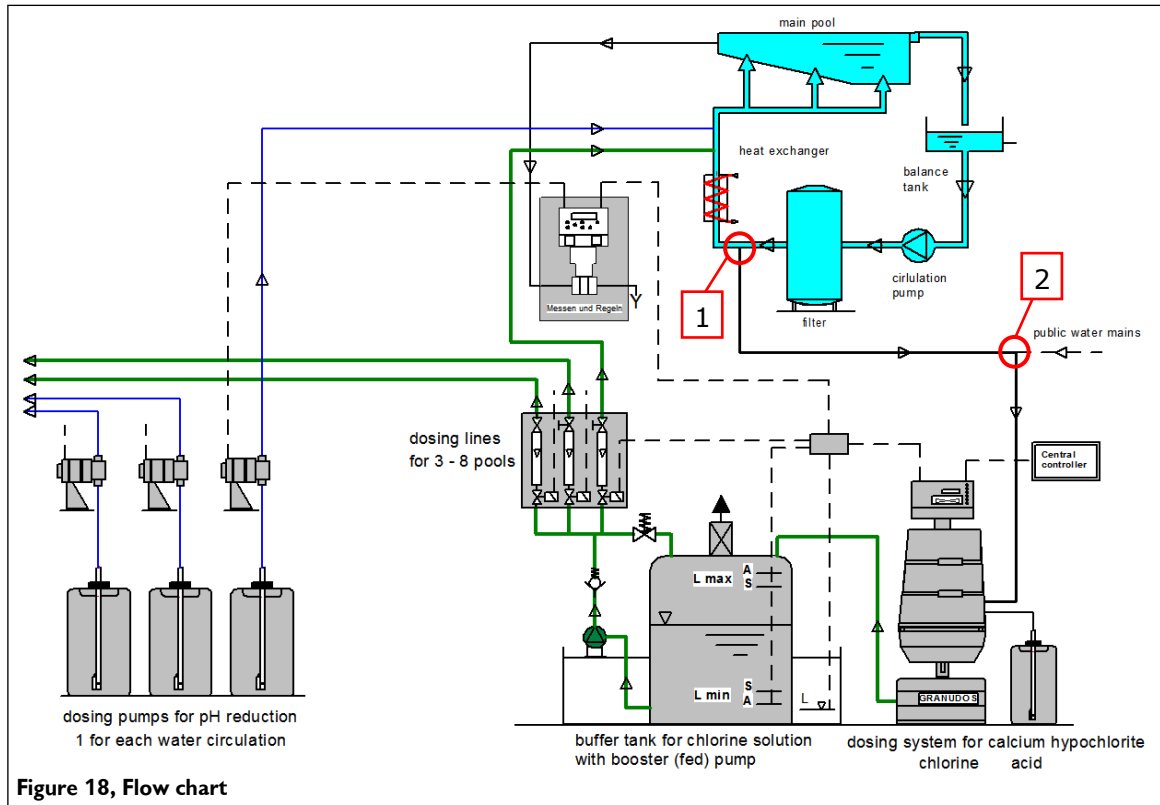

Figure 18, Flow chart

Usually the GRANUDOS is supplied with clean water. In exceptional cases - brine water, well water or thermal water - the system must be supplied with tap water.

Water removal point

If there are any existing connections, ensure that they are not blocked. The pipes should be kept as short as possible. The piping of the supply line in PVC must be executed in the dimension d25-3/4". Increase the nominal width for lines longer than 20 m or in case of poor pressure conditions.

Ensure that the connection sleeves for the water removal and the dosing point are completely open (metal sleeves may potentially be rusted shut).

Avoid a rising and falling of the intake line in the piping to the GRANUDOS PLUS. This can lead to the formation of air cushions that may subsequently enter the pump during operation and cause faults. Connect the intake nozzle of the GRANUDOS PLUS with the water removal point.

There are 2 options for water removal:

Water supply 1, with swimming pool water:

- Removal of the dissolving water from the clean water line downstream of the swimming pool filter, if the flow pressure at the Granudos intake is at least 0.2 barg.

Water supply 2, with tap water:

- Only use the tap water supply if water supply 1 cannot be realised!

CAUTION!

If tap water is used, for the protection of the water network a system separation must be installed according to the locally applicable legal provisions (for Germany



and the EU: DIN EN 1717: 2011-08). This prevents a backflow of the swimming pool water into the pipeline network in the event of a pressure drop in the network!

Line connection design

Line connections should always be installed laterally.

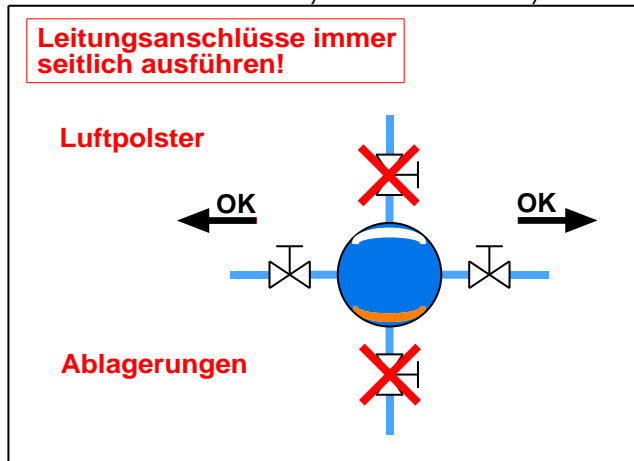

Figure 19, Line connections

Install a pipe from the overflow nozzle of the GRANUDOS PLUS to the gully.

4.4.2 Connect buffer tank (optional)



ATTENTION!

Due to the chlorine solution's corrosiveness, use only thick-walled pipes in PVC PN16 in the corresponding dimensions.

4.4.3 Connect feed system (optional)

At a minimum, the piping of the dosing lines from the distribution system to the injection points (downstream of the filters and the heat exchangers) must be executed in the dimension d20 mm (thick-walled) with ball valve and non-return valve. For longer dosing lines (above approx. 15 m) and a flow above approx. 400 l/h it is recommended to install a line with the next highest nominal width, due to the potentially increased pressure loss.



ATTENTION!

Non-return valves - ideally non-return ball valves - must be installed at the injection point. This prevents a backflow of swimming pool water into the buffer tank if the feed pump does not work and a control valve is not completely closed.

4.5 Electric installation



DANGER DUE TO ELECTRICAL VOLTAGE!

The electrical installation must only be carried out by qualified electrical technicians! Before any electrical work is carried out, the power supply must be switched off and secured against being reactivated!



ESD SENSITIVE!

The electronic components in the devices are sensitive to electrostatic discharges. The generally accepted safety precautions for ESD-sensitive devices must be observed when handling the devices.

In particular, the following applies for work on electronic components:

- Do not pull or plug in socket connections under voltage.
- As the person handling the device, please discharge yourself electrostatically for at least 5 seconds prior to directly touching the devices, e.g., by touching a grounded part of the system or by wearing an ESD antistatic wrist strap connected to ground.

The device must be supplied with continuous voltage. I.e., the voltage supply must not be locked with the filter system. An input from CCT is available for interlocking the filling with the swimming pool's filter system. For electrical installation, see also wiring diagrams in the controller's terminal casing or in *Chapter 9.2*.

4.5.1 Open and close the casing

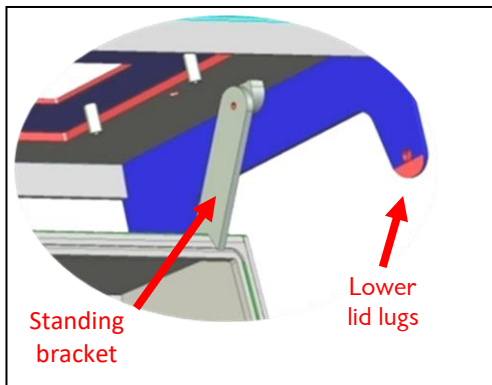

The casing is equipped with an “easy lock-in closure”. In order to open the display lid or the small connection space cover, the side lid lugs must be gently lifted outwards from the main casing. The display lid can then be pulled forward. The upper lid lugs run in guide grooves up to the front lock-in position.

Afterwards, the display lid is raised. The display lid can be supported on the main casing using a standing bracket so that it remains raised for work on the terminals.

In order to close the casing, the standing bracket must be unlocked with a backward motion and the lid closed by moving it downward. The upper lid lugs must now be unlocked and the lid pushed backward onto the main casing. In order to ensure that it has been completely resealed, press gently on the four corners of the casing.

The casing lid will close with a soft, audible click. Ensure that all of the lid lugs have been securely bolted using the safety bolts each time.

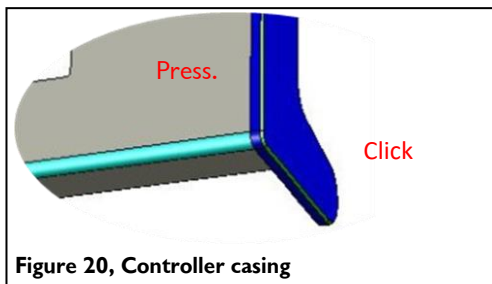

Figure 20, Controller casing

4.5.2 Electrical connection:

For electrical installation, see wiring diagrams in the GRANUDOS PLUS terminal casing or in *Chapter 9.2*. The control cable 10x0.5 mm² (5 m) that is already connected to the feed system, and the cable for the feed pump 3x1 mm² are connected to the controller of the GRANUDOS PLUS - see wiring diagram

The power supply for the dosing device must always be ensured.

The external control inputs and outputs (shut-down in the event of fault, etc.) must be clamped to the clamping connectors of the baseplate in the controller casing. Do not use any fixed wire conductors. See *wiring diagram in Chapter 9.2*.

Insert cables

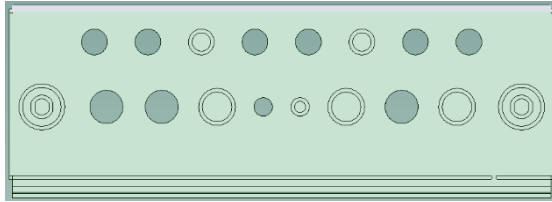

Several washers for metric cable glands are available for additional insertions.

The two external screw connections with M25 are intended for the insertion of a preassembled interface cable with RJ45 plug.



ATTENTION!

Please observe the spatial separation between energy and signal lines when inserting additional cables. The crossing of energy and signal lines must be avoided!

Upon completion of the work, the casing must be properly closed again!

The control cables of the measuring and control technology for the control valves 240VAC for the chlorine dosing are clamped to the relay plate (SL2 to SL9) at the back of the mounting plate in the terminal box

Electric connection / external connection to the control centre:

To ensure that the GRANUDOS PLUS does not produce when the filter pumps are switched off or when the water supply is not guaranteed, the GRANUDOS PLUS must be interlocked with the filter system by the CCT (Central Control Technology).

Signals to external - potential-free outputs:

The Granudos system provides the following signals for external processing:

- Collective fault indication to the CCT (Central Control Technology)
- Reserve message chlorine / acid
- Empty signal chlorine / acid

Signals from external - potential-free inputs:

The Granudos system can be activated via a CCT:

- When the filling is switched off by the CCT, the feed pump continues to run until it reaches the "Start buffer tank filling" level.
- Switch off the feed pump with the control valves for the chlorine dosing.

5 Commissioning

5.1 Commissioning - remarks



ATTENTION!

This chapter must also be observed every time recommissioning occurs after an operating pause. Do not switch on the GRANUDOS 45/100 PLUS until the flushing tub has been filled.

The work described here may only be carried out by trained specialist personnel. Prior to commissioning, the installed systems must be checked for proper installation and leaks.

Please use the commissioning protocol from *Chapter 9.3.* for commissioning. The device is delivered with defined ex works settings. You can find the setting values in the operation data sheet in *Chapter 9.4, Operation data sheet.*



ATTENTION!

During the installation of the piping and the electrical system, foreign objects may have fallen into the flushing system, which could lead to potential faults in the float valve or the suction pipe of the flow switch. Remove foreign objects!

Remarks

- At the startup, **all faults are suppressed for 12 seconds** to ensure a constant flow in the flushing tub. Afterwards, the filling starts unless a fault is present.
- During operation/filling, a fault must be pending for **longer than 6 seconds** before the GRANUDOS PLUS is switched off.
- The No chlorine switch on the mixing cyclone must detect chlorine granulate within 8 seconds after the start of the 2nd dosing interval. The LED on the No chlorine switch is illuminated when a sufficient amount of chlorine rotates in the cyclone.
- After the Buffer tank full notification, the current dosing cycle continues to be completed. Next, acid is dosed for 20 seconds, followed by flushing with water for another 20 seconds.
- The dosing pipe's heater is always turned on.

5.2 Commissioning, setting of the operating parameters

Prior to commissioning, ensure that the intake ball valve is open.

5.2.1 Installation of peristaltic pump, roller carrier

The acid pump is installed on the right side of the STANDING COLUMN of the GRANUDOS 45/100.

- 1) Remove the clipped-on, transparent pump cover. Remove the lock washer. Pull the hose bracket forward out of the guide in the casing.

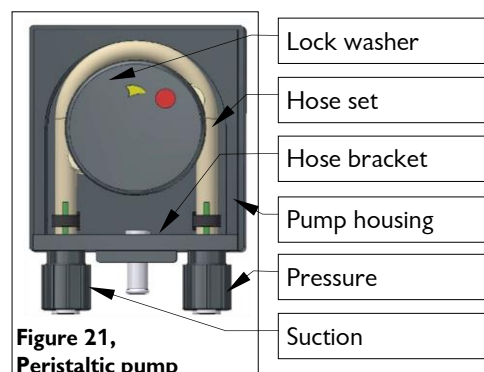

- 2) Push the enclosed yellow roller carrier onto the axle.



- 3) Insert the hose bracket into the casing's dovetail guide until it is flush with the front

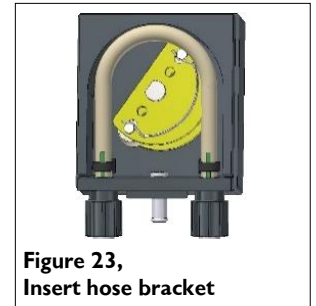

Turn the roller carrier. In the process, carefully press the hose into the casing over the flat area in the roller carrier until the hose is located completely inside the casing. Continue to turn several times.

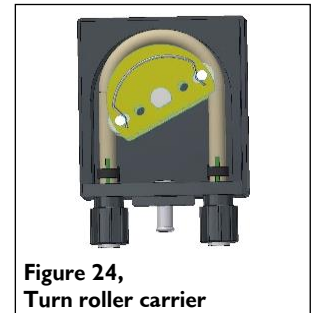

Now replace the lock washer and the transparent pump cover. The roller carrier installation is completed.

For dismantling the roller carrier and the hose bracket, proceed in the reverse sequence.

5.2.2 Prepare acid dosing for operation



PROTECTIVE CLOTHING!

**Personal safety equipment must be put on before starting work with chemicals:
Protective gloves, apron, face protection, boots.
The specifications for each chemical listed in the safety data sheets must be observed.**

Connect/change acid canister

During commissioning

- a) Place the full acid canister into the collecting tub
- b) Unscrew the screw cap from the full acid canister. Insert the suction lance into the canister all the way to the bottom and close with the screw cap.
- c) Store the acid canister's original screw cap until the next time the acid is replaced.

The acid dosing is now ready for operation

When changing the container

- a) Remove the empty acid container from the protection tub, place the full container in the tub and unscrew the lid.
- b) Unscrew the screw cap with the suction lance from the empty acid canister.
- c) Insert the suction lance into the full canister all the way to the bottom and close with the screw cap.
- d) Close the empty acid container and safely dispose of it.

5.2.3 Attach/change the drum



PROTECTIVE CLOTHING!

Personal safety equipment must be put on before starting work with chemicals:
Tight-sealing goggles, protective gloves, apron, face protection, boots
The safety data sheets for each chemical must be observed.



ATTENTION!

At the time of the order, the GRANUDOS 45/100 was designed for a certain type of chlorine drum. As a rule, the dosing head does not fit on chlorine drums by other manufacturers. If a dosing head is improperly installed on a different drum, it may detach from the drum during turning, causing the chlorine granulate to drop to the ground. The removal of the chlorine is unpleasant and time-consuming! This circumstance should be taken into account when purchasing the chlorine.

The chlorine granulate and the acid must not be mixed with each other or with other chemicals or substances!

Remove potential encrustations from the dosing hopper (23) to avoid faults in the chlorine dosing.



Tip!

When ordering the calcium hypochlorite drum, pay attention to the correct combination of the dosing head!

It is recommended to roll the new, sealed drum several times on the floor prior to attaching it to the dosing device to loosen any potential clumps in the granulate.

Check the quality when opening the chlorine drum

The following can be checked upon delivery to gain an initial impression of the quality:

The granulate must be white, free of clumps, and no strong chlorine smell must be present when opening the drum. **For more detailed notes regarding the chlorine specification, see Chapter 3.4.1, page 22.**

5.2.3.1 Attach the drum with tension band and safety belt

Stop dosing via the  button when changing the drum.



DANGER!

When changing the drum, ensure that the Dissolving system is covered. Negligence, the dropping of large amounts of granulate or a lack of cover can cause deflagration!

Overview of GRANUDOS PLUS:

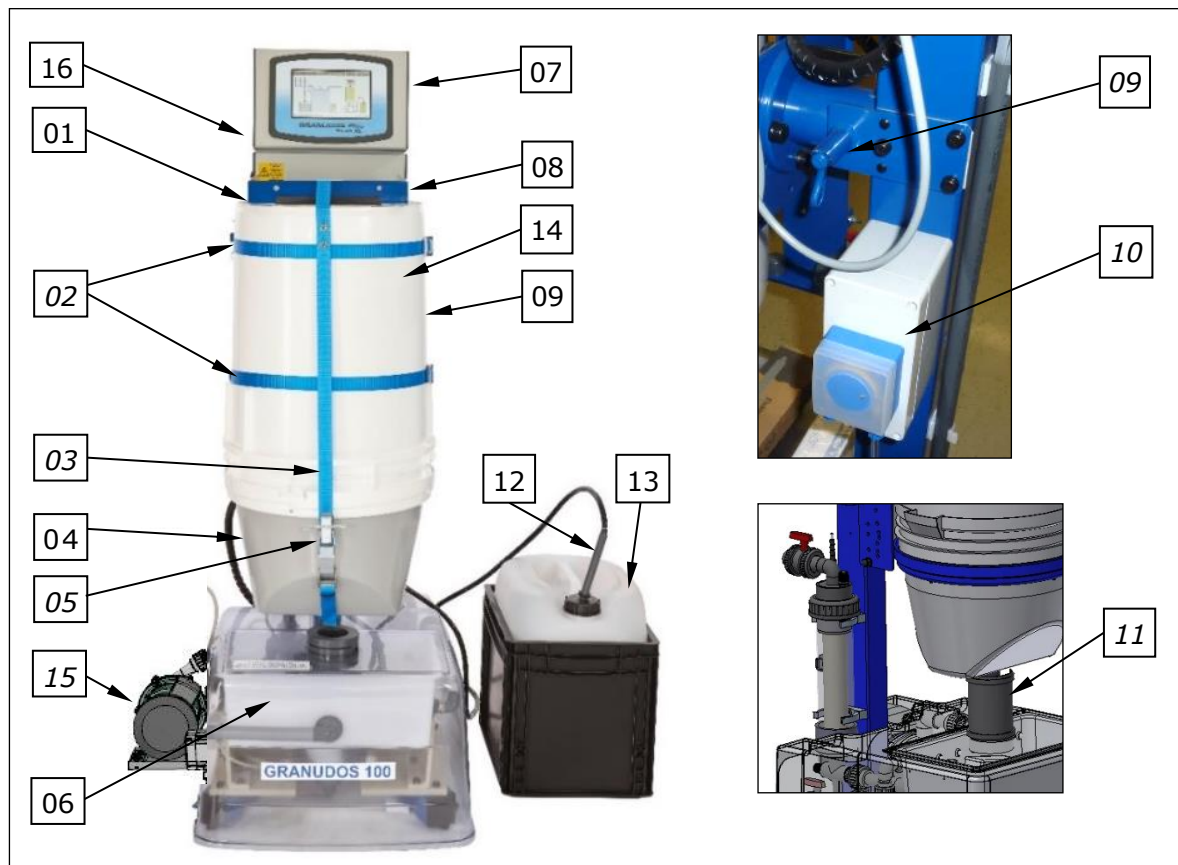

Figure 25, GRANUDOS PLUS

- | | |
|--|---------------------------------------|
| 01. Drum holder | 10. Acid pump (covered) |
| 02. Tension bands | 11. Dust protection, protective pipe |
| 03. Safety belt | 12. Suction lance for acid |
| 04. Dosing head | 13. Acid canister with protection tub |
| 05. Clamping lever for the safety belt | 14. Chlorine drum |
| 06. Dissolving system | 15. Dust extraction |
| 07. Controller | 16. Main switch |
| 08. Identification plate (on the right side of the upright pipe) | |
| 09. Spring bolt for the turning device (covered) | |

Procedure for replacing the drum:

- Push the dust protection pipe (11) downward.
- Loosen the spring bolt (09) of the turning device and rotate the turning device with the empty drum clockwise from the dosing position upward; while doing so, keep the dosing pipe covered with a finger to prevent any granulate from escaping. Relock the turning device. (This point does not apply during the initial commissioning.)

- c) Loosen the safety belt (03) and the tension bands (02). Remove the empty drum from the turning device. Unscrew the dosing head with a counter-clockwise turn and place it next to the dosing device. (This point does not apply during the initial commissioning.)
- d) Align the drum on the floor so that the recessed grips point sideways.
- e) Unscrew the lid from the new drum and remove the measuring cup, if present.
- f) Place the dosing head on the drum and screw it tight until the control cable is located on the right side.



ATTENTION!

Ensure that the dosing head correctly engages with the drum's thread without jamming and that a proper connection exists after it has been screwed in.

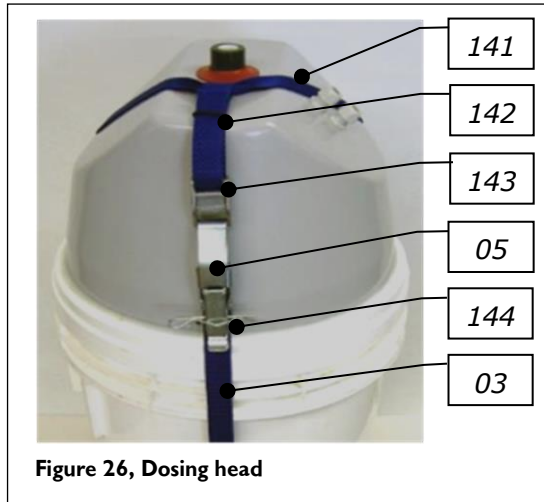

- 03. Safety belt (general)
- 05. Clamping lever for the safety belt
- 141. Carrier belt
- 142. Adjusting belt
- 143. Clamp lock
- 144. Safety pin

- g) Place the new drum on the turning device so that it is leaning against the posterior tracks and the lower spacers and the holding rod engages with the drum's cross ribs.
- h) Next, pull the tension bands around the drum and close the tension lever. The tension lever must be tightly closed; however, do not use excessive force when turning the tension lever. The length of the tension band must be adjusted correspondingly at the screw ends.
- i) Insert the safety pins in the tension levers!
- j) Pull the safety belt's carrier belt (141) over the heating nozzle from behind so that the bolt's clamp lock (143) is located on the front of the hopper. Insert the safety belt's clamping lever (05) in the clamp lock, pull it tight and secure with the safety pin. If the safety belt is not tight, adjust the length of the adjusting belt (142) accordingly. Insert the safety pin (144)!



ATTENTION!

Ensure that all safety pins have been inserted!

- k) Unlock the drum holder by turning the turning device's spring bolt (09) upward. Cover the dosing pipe with a finger and slowly turn the drum counter-clockwise in the dosing position. Lock the drum holder by turning the tension bolt downward. Ensure that the control cable does not get entangled.
- l) Orient the dust protection pipe in the flushing tub lid so that any potential air current does not blow away the fine chlorine dust. (Distance of the protection pipe's upper edge from the dosing head approx. 1-2 cm). Minimise air draft - close doors!

5.2.3.2 Attaching with drum bracket type FH2 (optional)

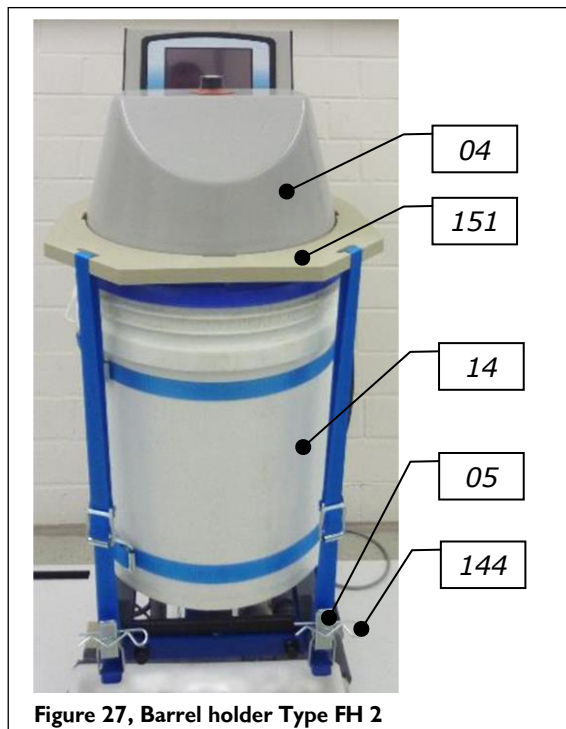

- 04. Dosing head
- 05. Clamping lever for the safety belt
- 14. Chlorine drum
- 144. Safety pin
- 151. Retaining ring

Figure 27, Barrel holder Type FH 2

- a) Loosen the spring bolt of the drum holder's turning device (09). Rotate the turning device with the empty drum clockwise upward; while doing so, keep the dosing pipe covered with a finger to prevent any granulate from escaping. Relock the turning device. This point does not apply during the initial commissioning.
- b) Remove the safety pins (144) at the lower carrier belts and open the clamping lever (05).
- c) Press the retaining ring (151) upward over the hood until it snaps into place.
- d) Remove the empty drum from the turning device, remove the dosing head (04) and place it on the floor to the side.
- e) Remove the lid from the new drum and remove the measuring cup, if present.
- f) Place the dosing head on the drum and screw it tight until the drum's recessed grips point sideways and the control cable points backward.
- g) Lift the drum with the dosing head onto the turning device.



ATTENTION!

The sloped sides of the hopper hood must point forward and back; otherwise, the retaining ring does not fit! – See illustration - Watch the dosing head's control cable to prevent the protective pipe from being bent!

- h) Next, pull the tension bands around the drum and close the tension lever. The tension lever must be tightly closed; however, do not use excessive force when turning the tension lever. The length of the tension band must be adjusted correspondingly at the screw ends.
- i) Insert the safety pins in the tension levers.
- j) Pull the retaining ring (151) down until it rests on the hopper's edge and fasten the carrier belts
- k) Insert the safety pins (144)



ATTENTION!

Ensure that all safety pins have been inserted!

- l) Rotate the turning device with the drum counter-clockwise downward into the dosing position. Once again, cover the dosing pipe with a finger. Lock the turning device.
- m) Orient the dust protection pipe (11) so that any potential air current does not blow away the fine chlorine dust. (Distance of the protection pipe's upper edge from the dosing hopper approx. 1-2cm).

5.2.4 Venting of the booster pump and the piping to the GRANUDOS

The pump and the piping must be carefully vented prior to each commissioning of the GRANUDOS PLUS to prevent the booster pump from running dry. The following should be observed in this regard:

- a) Check manually whether the pump shaft can be turned with ease. To do so, use a screwdriver to turn the fan propeller in the back. If the shaft does not turn smoothly, the mechanical seal is clotted. Loosen the shaft by abruptly turning it back and forth. If this does not solve the problem, the pump must be deinstalled and disassembled to loosen the mechanical seal.



ATTENTION!

If the pump is switched on with a blocked mechanical seal, the pump's failure is preprogramed.

- b) During commissioning, open the ball valve at the water removal point and the dosing point; then open the dirt filter and wait until the flushing tub is half full. This ensures that water has flowed through the pump and the pump has been vented. Then open the outflow ball valve downstream of the cyclone.
Next, switch on the GRANUDOS at the main switch (16).
- c) Now observe the dirt filter d75.
If the filter's water level shows a significant drop when the pump is switched on, turn off the GRANUDOS at the main switch, open the venting screw on top of the filter and allow water to flow back into the filter before switching the machine back on.
If necessary, repeat the process several times until the filter remains full; a few air bubbles in the upper filter area are not relevant.



ATTENTION!

If the pump draws air while in operation or during unmonitored activation, the pump's mechanical seal will run dry, overheat and start to leak. This can be the case with an installation above the swimming pool level, when draining the supply line or when turning off the filter system.

5.2.5 Initial filling of the feed system's buffer tank

Prerequisites:

The GRANUDOS PLUS system is completely connected and the water supply has been ensured. The chlorine drum has been attached and the suction set for the acid is connected to the canister.

The startup programme:

- a) Turn on the device at the main switch (unless this has already been done). The startup programme is automatically activated by the Minimum level alarm switch.
- b) The GRANUDOS PLUS now fills the buffer tank without chemicals for 10 minutes. Fault indications from the feed system will not be considered during this process.
- c) During this time, the **water flow in the Dissolving system** and the **water level in the flushing tub** must be adjusted. (see Chapters 5.2.6 and 5.2.7)
- d) After 10 minutes, the GRANUDOS PLUS switches off automatically. The water level should now be above the feed pump's pressure socket. The display shows the following notification: → or .
- e) If the required level has not yet been reached, confirm with ; the buffer tank will be filled for an additional 10 minutes, until the device again queries the level or the Level full switch automatically stops the filling.
- f) When confirming with , the following prompt is shown: **Vent the feed pump** (see Chapter, 5.2.9, Venting the feed pump). For the design without feed system, confirm the notification with .
- g) Once the query is confirmed, the operating programme starts.
Continue with Chapter, 5.2.11, Calculating the dosing lines' flow capacity
This point does not apply when only the buffer tank was ordered without feed system.



NOTICE!

During the initial filling of the buffer tank, the settings must be adjusted according to Chapters 5.2.6 to 5.2.8

5.2.6 Setting the water flow in the Dissolvin system

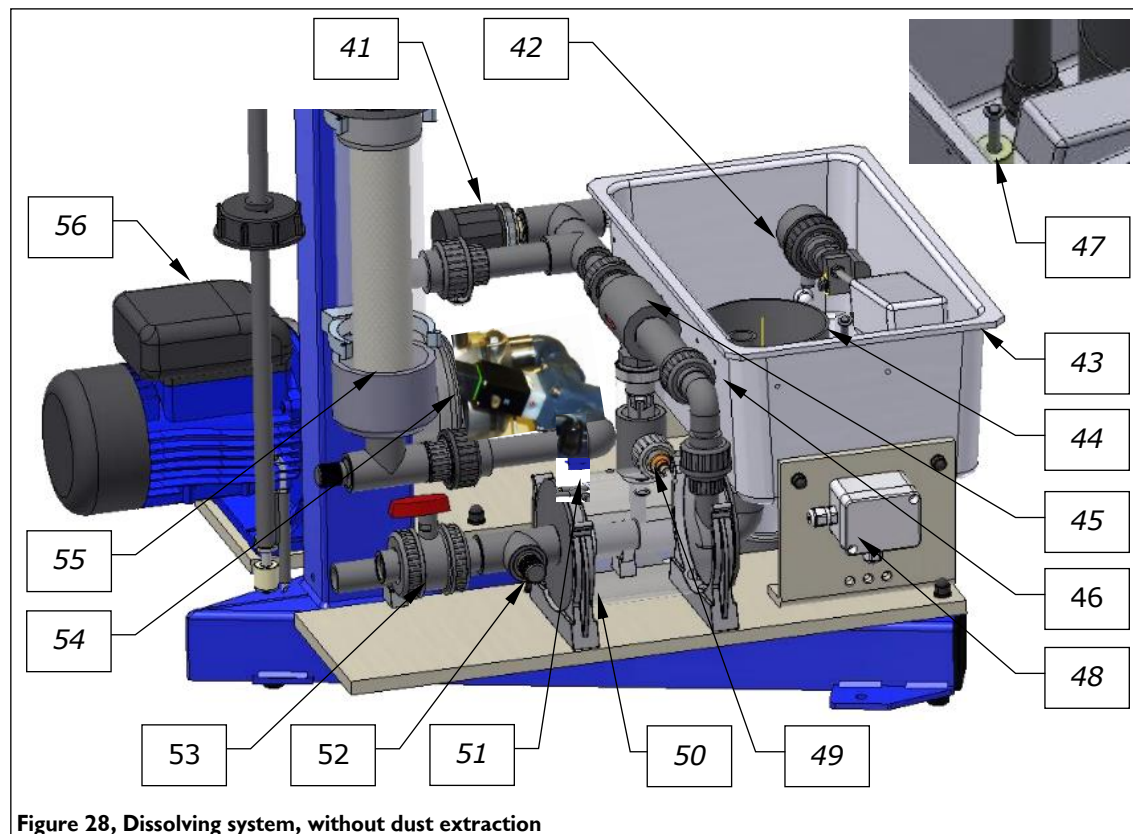

Figure 28, Dissolving system, without dust extraction

- | | |
|--|--|
| 41. Pressure switch | 50. Dissolving cyclone |
| 42. Float control valve in the flushing tub intake | 51. No chlorine switch / sensor on the cyclone |
| 43. Flushing tub | 52. Connection for manometer |
| 44. Flushing pipe | 53. Outflow ball valve for booster water |
| 45. Injector | 54. Control valve for the dissolving water |
| 46. Screw connection with hole washer | 55. Dirt filter d75 mm |
| 47. Level switch min. /max. Flushing tub | 56. Booster pump (various designs) |
| 48. Connection socket for the switches | |
| 49. Flow switch for suction pipe | |

The hole washer in the screw connection (46) behind the injector (45) adjusts the injector's suction performance to the pressure conditions:

If the water level in the flushing tub (43) drops during commissioning, the injector's suction performance is too high and it is necessary to insert a washer with a smaller drill hole in the screw connection (46).

If the water level rises, or if the flow switch (49) switch body is not clearly pushed upward, the injector's suction performance is too low and a washer with a larger drill hole is required, or the washer must be removed entirely.

A washer with 6 mm is installed ex works; washers with 5.5 mm and 7 mm are available in the enclosed spare parts bag.

5.2.7 Setting the water level in the flushing tub

The water level in the flushing tub can be changed by screwing the float at the *float control valve* (42) in or out. A higher level is achieved by unscrewing the float, a lower level by screwing the float in. One revolution corresponds to approx. 1cm. Adjust the float in the flushing tub so that the water level corresponds approximately to the centre of the flushing tub.

5.2.8 Setting the pressure switch

The pressure switch (41) records the booster pump's (56) effective pressure. This pressure monitoring ensures that the GRANUDOS dosing device switches off if the switching pressure falls below the set value, e.g., when air is drawn in or in the event of a pressure drop in the water supply. This ensures that:

- The dosing is turned off if the booster pump does not transport enough water.
- The booster pump is not exposed to the risk of cavitation.

To set the switching point, the dosing device must be in operation (= buffer tank filling).

- a) Remove the cover from the pressure switch.
- b) Turn the adjustment knob 0.25 bar to the left and wait for 6 seconds.
- c) If the dosing device continues to run, repeat the process until the dosing device stops and the fault indication  "Minimum pressure alarm" appears. The GRANUDOS dosing device stops.
- d) Now turn the adjustment knob 0.25 bar to the left and confirm the alarm message.
- e) The dosing device will start up again.
- f) Now, the dosing device will throw a fault at a pressure drop of 0.25 bar.

A switching point of 1.5 barg is preset ex works.

5.2.9 Venting the feed pump



ATTENTION!

The feed pump must be vented prior to being switched on! Otherwise, there is the risk of damage to the pump due to overheating.

During the buffer tank's initial filling (without chemical dosing), the following prompt appears after confirming the filling when a sufficient level has been reached: **Vent the feed pump**. To do so, open the ball valve (Pos. 80, Page 16) in the venting line that leads back to the container and start the pump by pressing the  button. The pump is vented after approx. 15 seconds, once the water flows back into the container, and the ball valve is closed again.

5.2.10 Setting the pump pressure at the feed pump/pressure retention valve (optional)

- a) Open all shut-off valves and control valves on the dosing lines
 - b) Reduce the pump output to a minimum (only for version with frequency converter).
 - c) Setting the calculated flow volumes (see *Chapter 5.2.11*) with the feed system's membrane valves (Pos. 91, p. 17).
 - d) No water should flow out of the return pipe (Figure 30) to the buffer tank. If water flows out, reduce the pressure control valve by **turning the adjusting screw clockwise** until no more water escapes.
 - e) Close all control valves (hand-operated)
 - f) Set the pressure retention valve in a way that a finger-thick water jet flows out of the return line. This is necessary to cool the feed pump (see *Figure 30*).
 - g) Check the flow rates. If the flow rates differ, repeat the process from step c).
 - h) If the **required flow rates are not reached**, increase the pressure in the metering lines. The **pressure is increased by turning the adjusting screw on the pressure retention valve clockwise** and reduced by turning it counter clockwise (see pressure gauge).
- **Version with frequency converter:**
In the design of the **feed pump with frequency converter**, the pump output can be changed at the potentiometer of the frequency converter. The settings of the **frequency converter and the pressure retention valve are interdependent**. The higher the pump pressure is set, the more the pressure retention valve has to be throttled. The pump has to generate an unnecessarily large amount of power, which reduces its life cycle time of the pump. This means that **the pump power should only be set as high as it is really necessary, but at least 1.0 barg!**
- i) Increase the pressure until the calculated nominal flow is reached in all opened dosing lines!
 - j) The total flow through the dosing lines must always be lower than the maximum filling capacity of the GRANUDOS PLUS! This means that at the full dosing capacity, the GRANUDOS PLUS still has to fill the tank slowly.



Figure 29, Distribution system, pressure retention valve, frequency converter

- k) Check the function of the pressure retention valve. Close all ball valves on the dosing lines. This simulates the situation when no valve is activated! When all valves are closed, a finger-thick waterjet as must emerge from the return pipe. This is necessary to cool the pump.

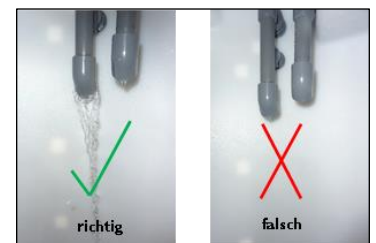

Figure 30, Return pipe



ATTENTION!

An incorrectly set pressure retention valve can destroy the pump.



Tip!

With the set dosing performance and open control valves, the GRANUDOS PLUS still has to fill the buffer tank slowly. The GRANUDOS PLUS has a filling capacity of up to 1200 l/h.

5.2.11 Calculating the dosing lines' flow capacity

The maximum chlorine dosing performance is indicated on the identification plate. This is based on a calcium hypochlorite concentration of 70% and granulate with a good dosing capability.

The flow capacity to be set on the dosing line or the required dosing performance of a dosing pump for the respective pool is determined based on the required chlorine dosing performance and the chlorine solution's concentration. The chlorine solution's concentration is determined at an assumed flow of approx. 1000 l/h in the GRANUDOS PLUS dosing device.



ATTENTION!

The sum of the flow capacities of all basins calculated in this manner may be up to 1000 l/h; if higher values are calculated, the chlorine concentration must be increased.

The calculated and set circulation performance for the individual dosing lines are entered in the *operation data sheet in Chapter 9.4*

5.2.12 Determining the dosing performance for the granulate dosing

The effective dosing performance for the chlorine granulate must be determined in order to calculate chemical consumption and thereby also the reserve message for the chlorine granulate. Provide a shallow collecting tub for approx. 250 ml (e.g., a shallow dish) and scales for this determination.



NOTICE!

Place a shallow collecting tub under the dosing pipe and follow the menu prompts. Weigh the dosing samples.

Determining the dosing performance:

Press **Menu** → **Settings** → **Determining dosing performance** on the start screen. Then follow the menu prompts.



Check the water level in the buffer tank prior to starting the determination of the dosing performance. The water level should be at the low fill level, since in the course of determining the dosing performance a filling with water only will occur for approx. 10 minutes, and the stop must not be reached prior to this.

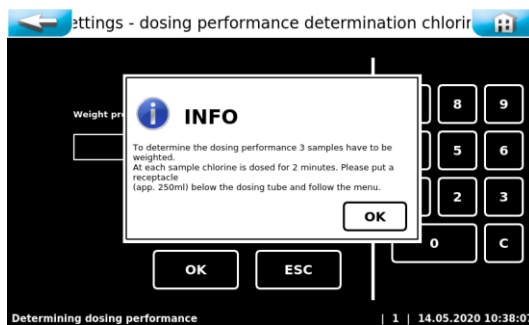

Place a collecting tub, e.g., a flat bowl, under the dosing pipe.

Figure 31, Determining dosing performance chlorine 1

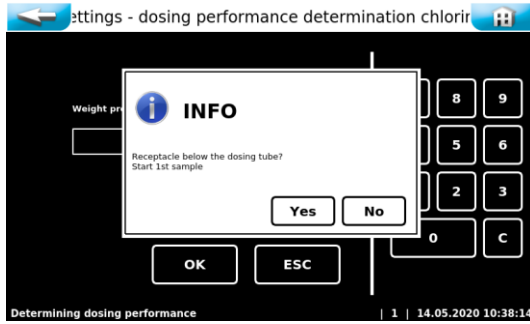
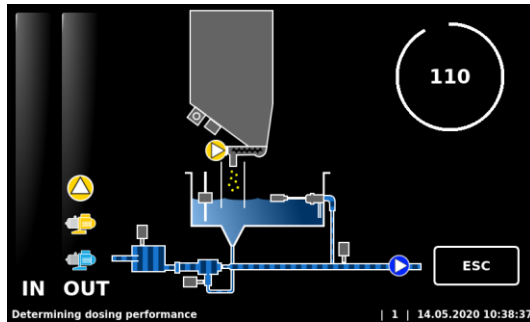
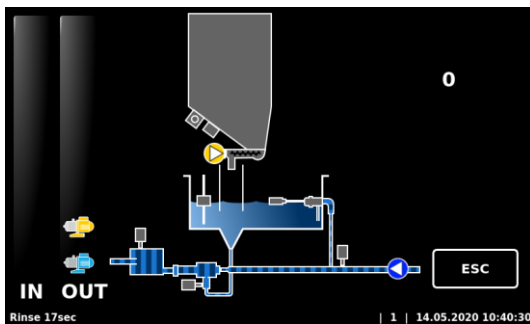

Figure 32, Determining dosing performance chlorine 2



Chlorine granulate is transported into the collecting tub for 2 minutes.



This is followed by 20 seconds of flushing.

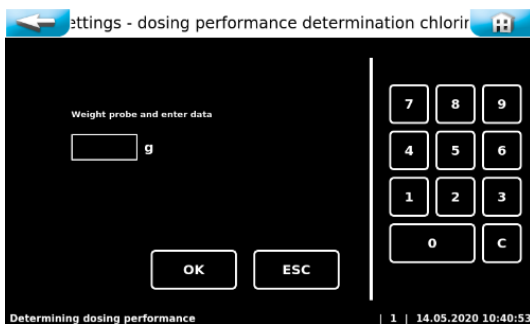

Weigh the dosing volume in the collecting tub with a letter scale.

Enter the determined weight in grams and confirm with **OK**.

This process is repeated 3 times in total. The programme then calculates the mean value of the 3 samples, thereby determining the dosing device's chlorine consumption.

Following the final weight entry, the device shows the actual dosing performance in continuous operation.

Confirm this value with **OK**.

Switch to the start screen via the Back button (white arrow).

Figure 33, Determining dosing performance chlorine 3



Tip!

If the granulate quality changes, e.g., if a different supplier is used, the dosing performance determination must be performed again to ensure that the reserve message is accurate.

5.2.13 Venting the pump dust extraction (Option)

The centrifugal pump of the dust extraction must be vented.



ATTENTION Risk of splashing!

Water may splash out when venting the pump!

Use face protection!

Use protective gloves!

- Fill the flushing tub with water up to the mid-filling level.
This fills the dust extraction pump with water, thereby preventing a dry run!
- Prepare the pump for venting; to do so, slightly loosen a screw connection on the pressure side
- Switch on GRANUDOS
INFO! Immediately after switching on, the flushing system initiates the flushing programme (dust extraction pump runs, solenoid valve opens)
- Vent the dust extraction pump and retighten the hose connection



Tip!

To test the flushing (without changing parameters), switch the GRANUDOS OFF and ON again at the main switch. The flushing then runs according to the set parameters (ex works: 10s flushing, 1h pause)

GRANUDOS standby operation, in this operation mode, the flushing also works according to the set parameters

5.2.14 Setting the dosing performance for chlorine and acid on the GRANUDOS

Main menu → Settings → Buffer tank / feed system

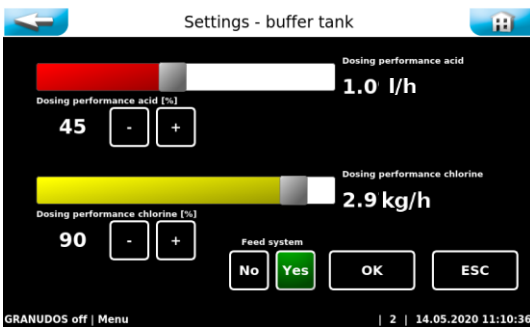

This menu makes it possible to set the **dosing performances for chlorine and acid** for filling the buffer tank and to **activate the feed system's function**.

Set a corresponding dosing performance for chlorine and acid. However, this must be **at least 50% for the chlorine**, due to the sensitivity of the "No chlorine switch" on the dissolving cyclone. A low dosing performance leads to a low chlorine concentration and thus a higher flow capacity at the dosing lines, see *Chapter 5.2.11*.

Figure 34, Dosing performance chlorine/acid

The dosing performance for the acid must be set so that the chlorine solution is pH-neutral (pH 7.0 +/- 0.2). The dosing performance required for this must be determined in accordance with the chlorine granulate's concentration, the hardness of the dissolving water / swimming pool water, the water's pH value and the acid concentration.

When using 37% sulphuric acid, the acid dosing is initially set to **50% of the chlorine dosing performance** (e.g., 30% acid with 60% chlorine).

- Wait approximately 2-5 minutes after the initial filling to allow the backflow to mix with acid and water.
- Measure and evaluate the chlorine solution's pH value: pH too high: more acid; pH too low: less acid.
- During the next filling, the new settings will be applied for the dosing. Then measure again and correct the acid dosing until the pH value has reached 7.00 +/- 0.2.

The filling is regulated automatically via the level switches in the buffer tank.

Feed system No/Yes:

Permanently activate or deactivate the "Feed system" function.

Only possible in the "Technician 1" user level!

At the same time, this function is used to switch the flow diagram display between feed system (yes) and buffer tank (no)

Explanation regarding the dosing process

Chlorine and acid are dosed at intervals with pauses between the dosing processes.

The dosing performance is determined by the dosing cycle (time between the dosing intervals) and the dosing times (running time of the dosing motors for chlorine and acid).

A dosing cycle always lasts for 30 seconds. The dosing time (=dosing performance) is set within these cycles:

- a) Chlorine dosing: 1-15 sec.
- b) Pause: 3.5 Sec.
- c) Acid dosing: 1-8 sec.
- d) Pause until end of cycle

There is always a mandatory pause of at least 3.5 seconds between the chlorine and acid dosing. The duration of the pauses changes automatically, depending on the length of the dosing time.

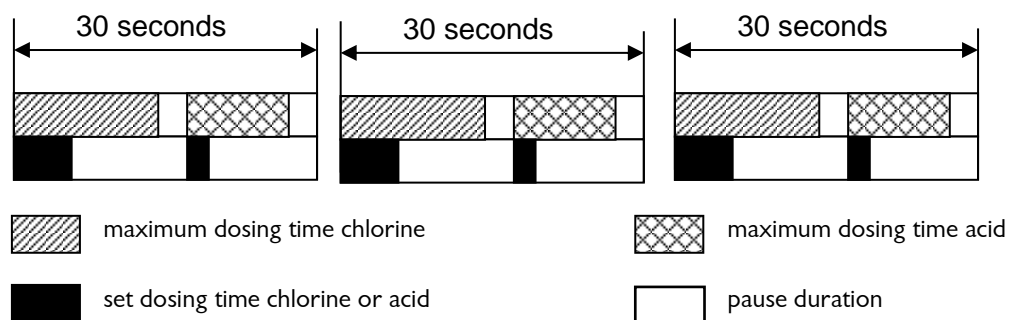

As a rule, 37% sulphuric acid is used as a pH reducer. With a high dosing performance and very hard water, it may be advantageous to dose hydrochloric acid.



ATTENTION!

The use of sulphuric acid is generally possible up to a concentration of 50%. For higher concentrations or when using other acids, e.g., hydrochloric acid, the changed dosing performance and/or increased corrosiveness must be watched for! We recommend consultation with the company WDT!



ATTENTION!

The effective dosing performance for the chlorine granulate also depends on the chemical's quality. An excessive proportion of fine particles or excessively coarse grains results in a reduction of the nominal performance.

For the exact determination of the nominal performance, see **Chapter 5.2.12.**



Tip!

A pH-neutral chlorine solution is clear and only has a light chlorine smell. A cloudy solution indicates a pH value that is too high. A clear chlorine solution with a strong smell indicates a pH value that is too low.

5.2.15 pH monitoring (optional)

During commissioning, the pH electrode must be calibrated. The pH monitoring is preset ex works. During operation the **calibration must be repeated every 3 months** and entered in the maintenance protocol.



CAUTION!

These ex works settings must not be changed:

Lower limit value pH 6.5

Lower limit value pH 7.5

Delay time 5 min

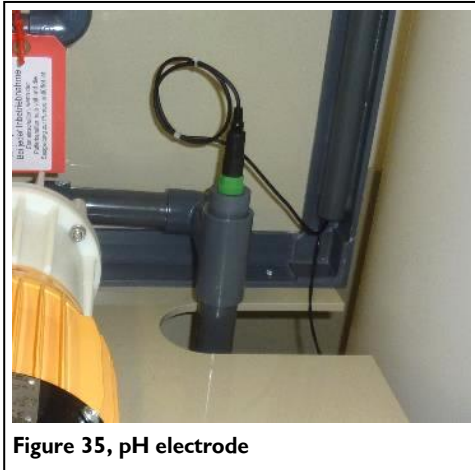



Figure 35, pH electrode

The calibration may only be carried out when the GRANUDOS is **not** in the operating status "Fill buffer tank"!

Switch off the GRANUDOS with the stop button . The feed pump stops. Close the shut-off ball valves of the dosing lines and the suction lines to the feed pump.

- Unscrew the connector plug from the electrode.
- Unscrew the pH electrode.

For internal pH measurement

See *Chapter 6.3.5, Main menu* → Calibration (Optional for design with internal **pH Monitoring**)

- Subsequently reinstall the electrode.

For external pH measurement

- See "Setting the pH monitoring" in *Chapter 10 Attachments*
- Subsequently reinstall the electrode.

6 Operation / service

Observe the nationally applicable accident prevention regulations (Germany: BGR/GUV-R 108 Operation of swimming pools).

6.1 Normal filling process during operation

Once all the preparations for commissioning have been completed, the GRANUDOS dosing system can be started. The device is already switched on (main switch).

Operating programme:

Press the Start button  to start the programme.

After the start, there will be 12 seconds of flushing with water only, followed by a continuous dosing of chlorine and acid, according on the setting. The GRANUDOS dosing device is only switched on and off via the level switches **“Start filling”** and level **“Stop filling”** in the buffer tank.

After switching off the dosing via the level **“Stop filling” = Container full**, the Dissolving system will be flushed for an additional 40 seconds to ensure that the GRANUDOS' Dissolving system remains clean. During the first 20 seconds, acid will be dosed.

6.2 The controller - Version GRANUDOS PLUS-V80 Touch

The controller of the GRANUDOS PLUS-V80 Touch is simple and easy to operate using the symbols and the menu prompts on the 7" touch display. The adjustment menus come with additional text-based instructions.

6.2.1 Operation display – Operating status – Operation messages

The operating states and faults are displayed directly on the start screen: see *below Figure 36, Automatic operation - start screen*.

In automatic operation, the current operating status, the fill levels and active inputs and outputs are displayed (IN – OUT). The inputs and outputs can be operation messages or fault indications.

Operating notes:

The current operating status is displayed in the status line (5) at the bottom left. The following operating states are available:

- Booster pump startup routine
- Standby
- Buffer tank filling
- Adjustment
- Flushing programme
- GRANUDOS OFF
- GRANUDOS ON
- Startup buffer tank filling

Desired parameter changes, calibrations and tests can be conducted by lightly touching the corresponding symbol or the numeric value.

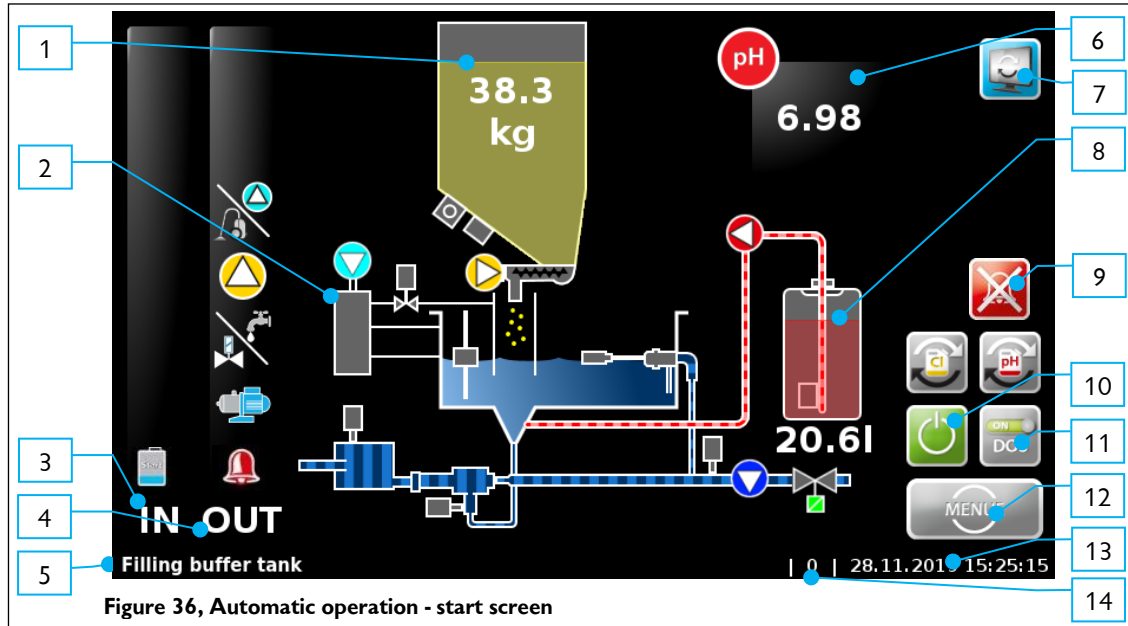









Figure 36, Automatic operation - start screen

Key:

- | | |
|--|--|
| 1. Fill level chlorine granulate | 8. Acid fill level |
| 2. Dust extraction (optional) | 9. Deactivate alarm |
| 3. IN list | 10. Start / stop dosing device with feed pump |
| 4. OUT list | 11. Manually activate / deactivate dosing |
| 5. Status line | 12. Menu button |
| 6. Measuring value pH (optional) | 13. Date / time bar |
| 7. Toggle between start screen and buffer tank display | 14. User level (0=guest, 1=end user, 2=technician 1) |

The **IN list** shows the input signals.
The **OUT list** shows the active output signals.

The function buttons on the start screen

-  Switch to buffer tank/feed system view
-  Reset chlorine counter (press when changing containers)
-  Reset acid counter (press when changing containers)
-  Switch dosing unit on/off
-  Skip startup delay, after start via CCT
-  Switch chlorine and acid dosing on/off, e.g., for service tasks
The chemical dosing is switched off for flushing the dosing system.
-  Deactivate alarm relay
-  Call up the main menu
The system is stopped completely when switching to the main menu.

IN list



Red = pH level (container for pH regulation empty)

Yellow = disinfection level (container for chlorine granulate empty)



The system is deactivated via the central control cabinet.
No dosing occurs, no alarm message given.



The pressure at the GRANUDOS booster pump is too low. The booster pump is stopped



The level in the GRANUDOS flushing tub is too low. The booster pump is stopped



The level in the GRANUDOS flushing tub is too high. The system is stopped



The flow in the GRANUDOS is too low. The system is stopped.



A fuse has been tripped. See log files to identify the fuse.

IN list (feed system/buffer tank)



Fault indication for the pH value in the buffer tank



Buffer tank filling is started,



The filling of the buffer tank with chlorine solution is stopped.



The buffer tank level has dropped too low. The system is stopped



The optical sensor on the cyclone did not detect any chlorine while the buffer tank was being filled. The filling was stopped - alarm.



The buffer tank level is too high.

Chlorine dosing, acid dosing and the booster pump are stopped. The feed system switches to the **emergency programme**.



Protection tub alarm (leakage)

Chlorine dosing, acid dosing and the booster pump are stopped. The feed system switches to the emergency programme.

Emergency programme: In the event of Maximum level alarm and/or Collecting tub leakage, a forced start of the feed pump occurs. The feed pump runs as long as one or both of the alarms are pending; this is intended to prevent a backflow of swimming pool water via the dosing lines.

OUT list



Red = acid dosing output active

Yellow = chlorine dosing output active



The alarm relay is active.



Chemical reserve – Indication for both chemicals

Advice notice for container exchange, check chemicals levels and prepare chemicals



The booster pump is active



Feed pump is active



The feed pump's motor protection was triggered



The knocker is active. This symbol is only displayed briefly.



Control valve for the dissolving water (54)



Dust extraction active



Dust extraction flushing. This symbol is only displayed very briefly.

6.2.2 Start –Booster pump delay and dosing delay

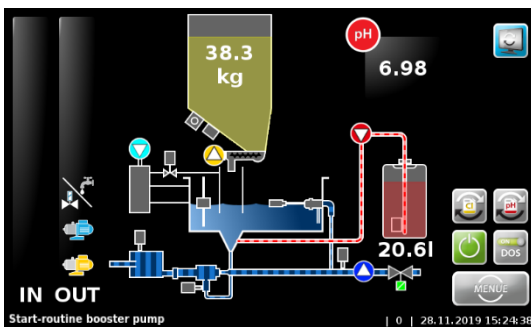

If the device is restarted, the **“Booster pump startup routine”** is running: The booster pump runs for 12 seconds without dosing. Software alarms are suppressed during this time.

The device then switches to the operating modus **“Buffer tank filling”** or **“Standby”**.

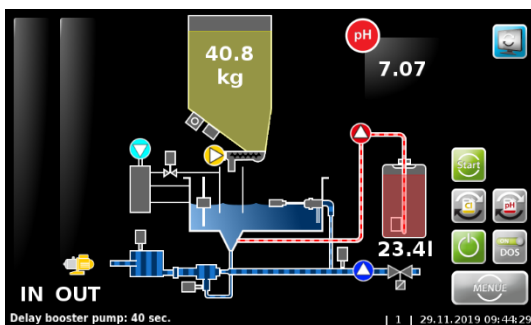

If **“Delay booster pump”** is activated, the delay time displayed in the status line expires prior to the start of the booster pump. Subsequently, the **Booster pump startup routine** starts. (This serves for venting the supply line.)

Use the  button (top right) to switch to the Buffer tank/feed system display.

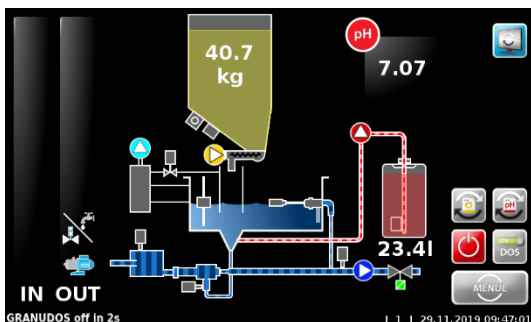

If the dosing device is switched off externally, dosing stops and the booster pump continues to run for 20 seconds to prevent any chlorine from remaining in the GRANUDOS. Afterwards, the GRANUDOS switches off.

6.2.3 Operating modus - Automatic operation

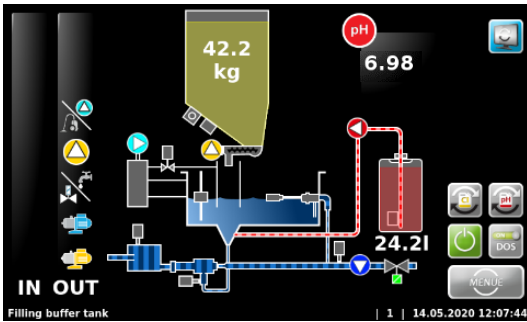

In normal operation, the device is in the “**Buffer tank filling**” operating modus. The device doses chlorine and acid in the set cycle.

The **OUT list** shows the currently active outputs as an example:

- Dust extraction
- Chlorine dosing
- Dissolving water control valve
- Booster pump
- Feed pump

There is no fault.

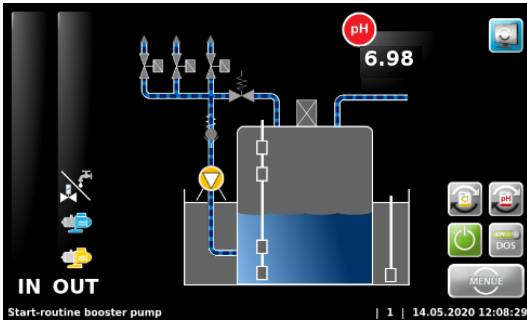

The illustration shows the Booster pump startup routine

OUT list: Booster pump and dissolving water control valve active

6.2.4 Alarms

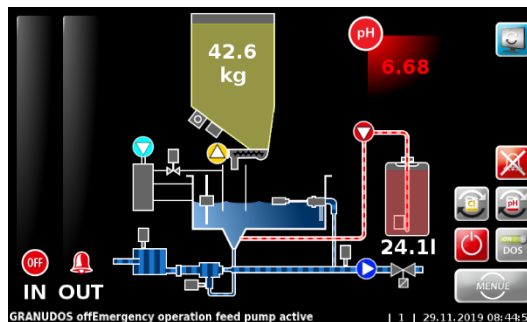

If an alarm occurs, this is signalled by the  symbol in the OUT list. The alarm relay is activated.

In the event of a fault, the corresponding symbol appears in the **IN list** - here, pH value too low.

Alarms or faults must be pending for 6 seconds before the signal is processed.

With the  button, the alarm relay can be temporarily deactivated without remedying the fault.

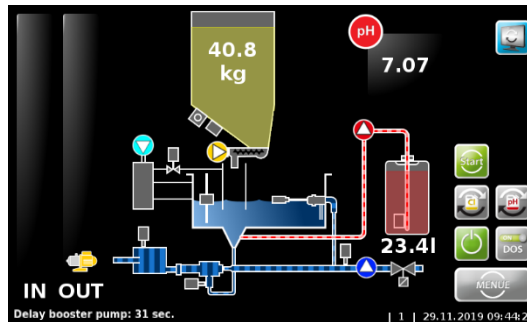

The GRANUDOS now starts with the startup routine.

If the fault subsequently recurs, or if the fault is not rectified, the alarm relay will be reactivated.

The illustration shows: everything OK

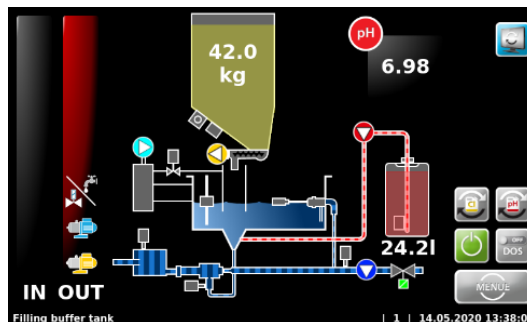

6.3 Main menu

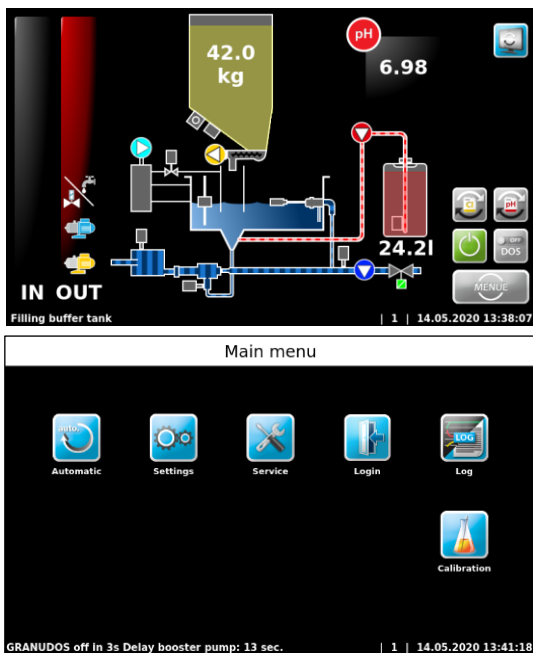

Automatic

Navigates to the start screen and into automatic operation; (= operating modes) switches automatically to user level 0 or 1



Settings

For adapting parameters and system settings



Service

Input and output test, info



Login

For password assignment; no password is assigned in the delivery state.



Log

For query of events and data logging



Calibration

Calibration of the pH electrode

6.3.1 Main menu → Login / Password

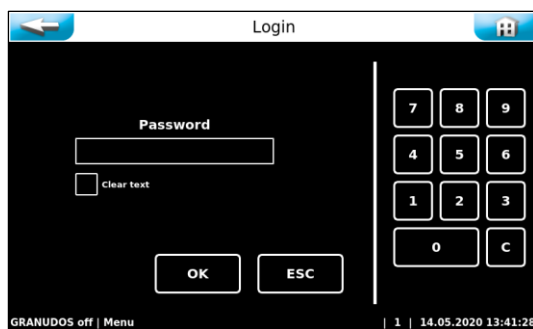

It is possible to assign a password. Passwords are assigned in the main menu under **Settings** → **System** → **Password**. A personal password protects the controller against unauthorised access. Settings, calibration, output tests, etc., cannot be performed without a password. You can still browse the menu and view the data logging.

If no password has been assigned for user level 1 (Technician), the system always switches to user level 1! If a password has been assigned for user level 1, the system switches to user level 0 (Customer) in automatic operation See *Chapter 9.4, Operation data sheet*.

A password is always required for user level 2 (technician 1).

For changes and adjustments, you must log in with your personal password. When switching to the start screen, the password must be entered again.











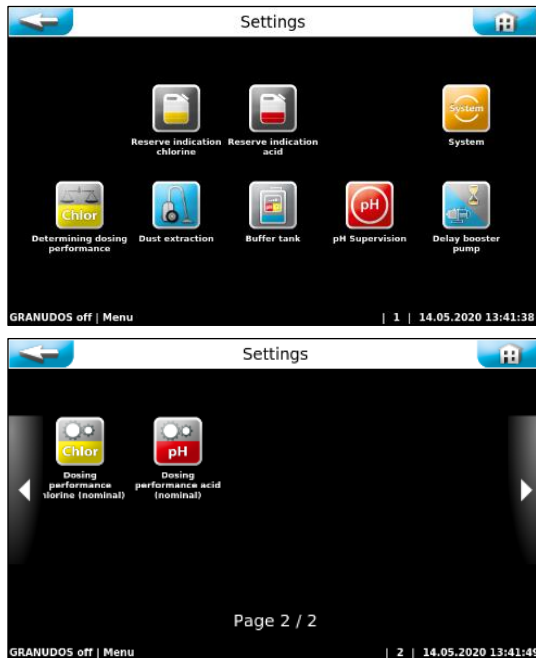

NOTICE!

Once a password has been assigned, unauthorised persons will be denied access to the control unit. The setting buttons will appear in grey. Desired changes can only be made after the password has been entered. Once a password has been assigned, make a note of it and keep it in a secure location.

6.3.2 Main menu → Settings (overview)

The “Settings” menu is used to implement the desired settings for the dosing device. Using the white arrow keys on the side, you can navigate to the next screen menu. The 2nd page is only displayed in user level 2 (Technician 1).



-  **Reserve indication chlorine (6.3.2.1)**
Set reserve message for chlorine granulate
-  **Reserve indication acid (6.3.2.2)**
Set reserve message for acid
-  **System (6.3.2.3)**
Set date, time, password, display, network and language
-  **Determining chlorine dosing performance (6.3.2.4)**
The effective dosing performance for the chlorine granulate is determined
-  **Dust extraction (optional) (6.3.2.5)**
Set parameters for dust extraction
-  **Buffer (operation with feed system / buffer tank) (6.3.2.6)**
Set dosing performance for buffer tank filling function
-  **pH Supervision = pH Monitoring (for operation with buffer tank) (6.3.2.7)**
Set monitoring limits for the pH value
-  **Delay booster pump (6.3.2.8)**
Set delay time for the start of the booster pump
-  **Dosing performance chlorine granulate (6.3.2.9)**
Set device-specific parameters Preset ex works, can only be set in Technician 1 level
-  **Dosing performance acid (6.3.2.10)**
Set device-specific dosing parameters Preset ex works, can only be set in Technician 1 level

6.3.2.1 Main menu → Settings → Reserve indication chlorine

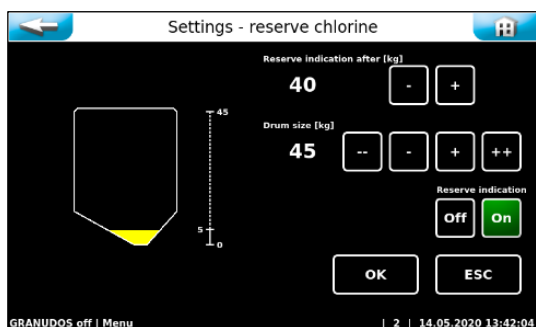

The quantities for which a reserve message will be displayed after dosing are indicated here, as well as the filling volume of the full container.

The message indicates that the chemical container will soon be empty.

The reserve message function can also be deactivated.

6.3.2.2 Main menu → Settings → Reserve indication acid

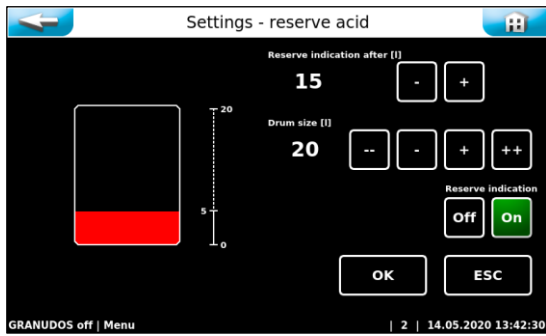

The quantities for which a reserve message will be displayed after dosing are indicated here, as well as the filling volume of the full canister.

The message indicates that the chemical canister will soon be empty.

The reserve message function can also be deactivated.

6.3.2.3 Main menu → Settings → System



Date/ Time

Set date and time



Password

Assign a password



Display brightness

Adjust the display brightness to the ambient conditions



Network

Set network parameters



Reset

Reset all parameters to the ex-works settings



Language

Select the user language



System ID

You can assign a name for the device here. This name will subsequently be displayed during remote access

a) Main menu → Settings → System → Date / Time

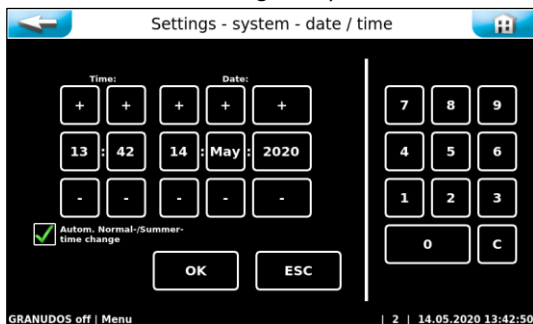

Adjust date and time.

You can activate automatic switching from winter to summer time.

b) Main menu → Settings → System → Password

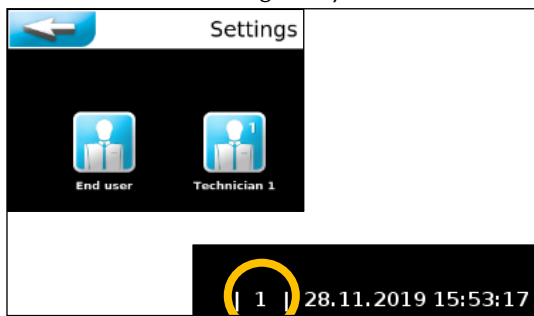

Guest (user level 0)

No password, read-only rights.

End user / end client (user level 1)

There is no ex works setting for an end user password. We recommend the assignment of an end user password to protect the system against unauthorised access. Enter the password in the operation data sheet. The individual end user password must contain four digits between 0000 and 9999. In the second line, the password must be entered once again.

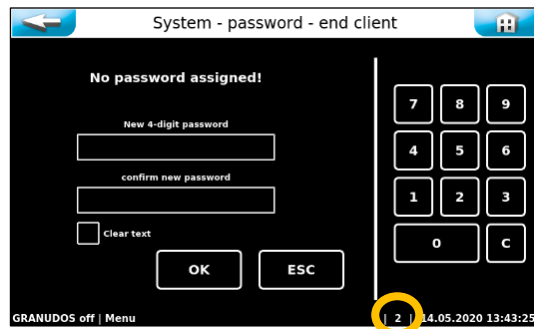

Technician 1 (user level 2)

The Technician 1 password consists of five digits and has an ex works default setting of 01234. This password is intended for the service partner. We recommend that you change this password as well and enter it in the operation data sheet.

If you place a green check mark next to Clear text, the entered numbers are shown instead of white dots.

To change an active end user password, it must be entered in the uppermost line. The new password must be entered in the two following lines.

If you wish to delete the end user password completely, simply enter the active password in the upper line. The other two lines remain empty.

If an incorrect password is entered, a fault indication appears.



NOTICE!

Make a note of the individually chosen passwords and store it securely in the operation data sheet. Lost passwords can only be reset by the factory customer service!

c) Main menu → Settings → System → Display

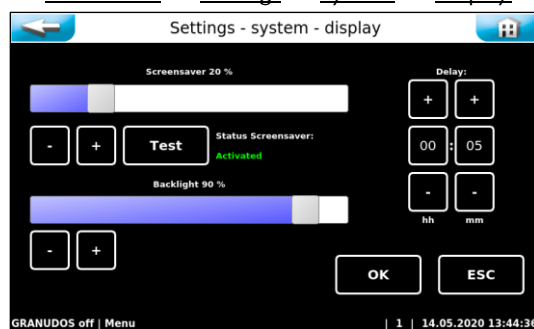

The screensaver dims the background lighting after the set delay time to the selected brightness.

The **Test** button can be used to test the settings.

The Backlight setting permanently reduces the background lighting in the operating mode.

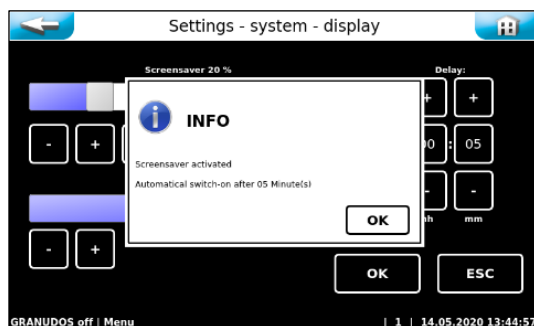

The screensaver can be activated or deactivated.

Save settings using **OK** and confirm the instruction text with **OK**.



NOTICE!

To extend the display's service life, reduce the background lighting to the minimal brightness required.

d) Main menu → Settings → System → Network → Configuration

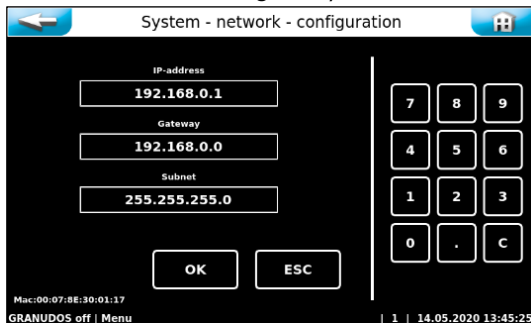

The touch panel has a LAN interface with RJ45 socket. The current status messages can be transferred to an external display via this interface. The terminal device can be a PC monitor, a tablet PC or a smartphone, e.g.

Further information is available upon request. The operator must establish the necessary IT requirements for remote access! (e.g., VNP connection, data security, etc.)

e) Main menu → Settings → System → Reset



This command can only be performed in user level 2 (Technician 1). All of the set parameters are reset here to the ex-works settings. For ex works settings, see *Chapter 9.4, Operation data sheet*.

Subsequently, all parameters must be entered again!

f) Main menu → Settings → System → Language



Select the desired operating language.

6.3.2.4 Main menu → Settings → Determining dosing performance

The effective dosing performance must be determined in order to calculate chemical consumption and thereby the reserve message. Without this determination of the dosing performance, the calculations are carried out using the ex-works settings, which can lead to deviations.

See *Chapter 5.2.12, Determining dosing performance = Nominal performance for the granulate dosing during commissioning*. For acid dosing, an exact performance determination is not required, since the peristaltic pump is sufficiently precise.

6.3.2.5 Main menu → Settings → Dust extraction (optional)

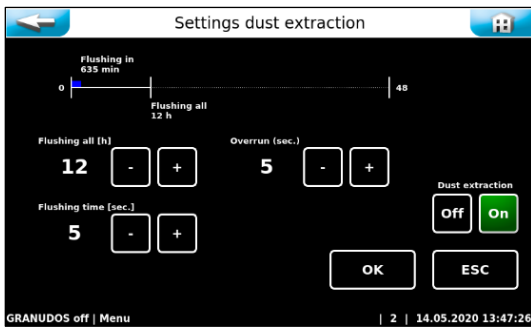

The dust extraction parameters are set here.

- Flushing: Set flushing interval; the flushing interval is the time between two flushing cycles. The blue bar indicates the time that has already elapsed.
- Run-on: Set run-on time, 0-60 sec, 0 = dust extraction deactivated; after completion of the chlorine dosing, the dust extractions continues to run for the set amount of time.
- Set flushing duration for transparent hose; the flushing valve opens for the set amount of time and the transparent hose is flushed.
- Switch dust extraction on / off (only possible in user level 2)
- Confirm settings using **OK**.

6.3.2.6 Main menu → Settings → Buffer tank / feed system

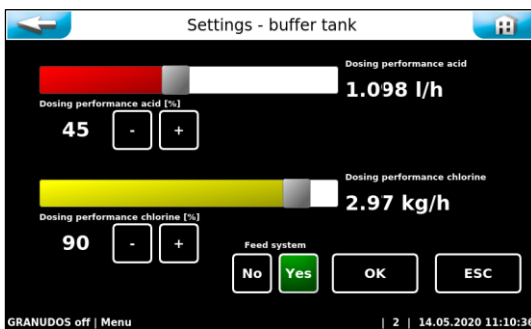

See *Chapter 5.2.14, Setting the dosing performance for chlorine and acid on the GRANUDOS, page 42.*

6.3.2.7 Main menu → Settings → pH Monitoring buffer tank

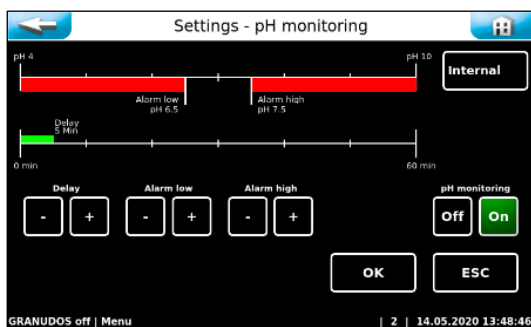

The parameters for pH monitoring and alarm message are set here.

- Delay: → adjustable time for complete mixing of the chlorine solution for an even pH value in the solution
- Alarm low: → lower alarm value
- Alarm high: → upper alarm value
- pH Monitoring off / on: → pH Monitoring operating mode on / off (only possible in user level 2 = Technician 1)
- Internal / external: → pH Monitoring via an internal or external measurement converter
- In the external setting, the alarm settings are faded out.

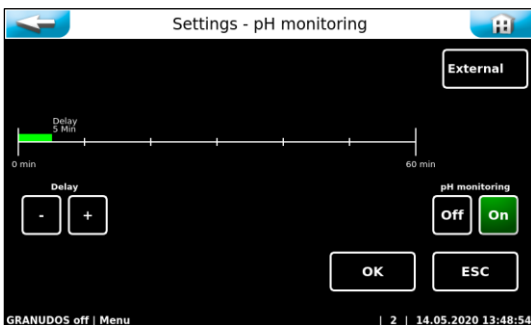

Info:

With an internal measurement converter, the pH electrode is connected to the measuring amplifier on the I-O board. With an external measurement converter, a separate pH regulator is installed at the feed system.

6.3.2.8 Main menu → Settings → Delay Booster pump

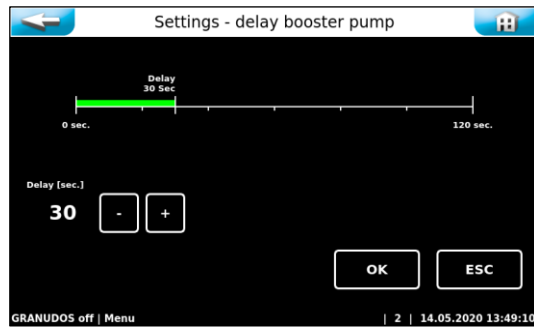

This function is active when the GRANUDOS is controlled externally (CCT off). Following a flushing of the swimming pool filter and after the set delay time has elapsed, the GRANUDOS is restarted. This ensures that no air remains in the pipe, which could lead to faults in the GRANUDOS.

6.3.2.9 Main menu → Settings → Installed dosing components / dosing performance chlorine granulate

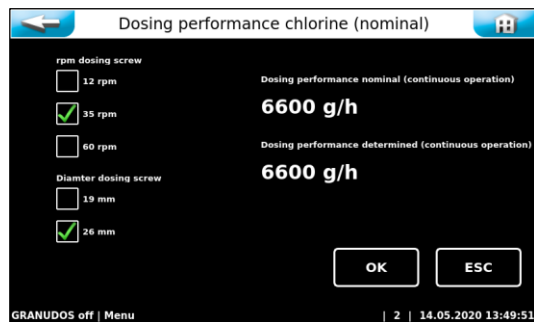

These settings can only be implemented in user level 2. The values set here depend on the dosing device design. They are preset ex works in accordance with the installed components; they are used as the basis for calculating the dosed quantities and the reserve message.

The dosing performance shown here pertains to the dosing in continuous operation under standard conditions. For a more precise determination of the dosing performance, see Chapter 5.2.12.



Attention!

These values may only be changed if the appropriate components have been installed in the dosing device. Otherwise, the dosing quantities will be determined incorrectly, leading to a faulty reserve message!

6.3.2.10 Main menu → Settings → Dosing performance acid - installed dosing components

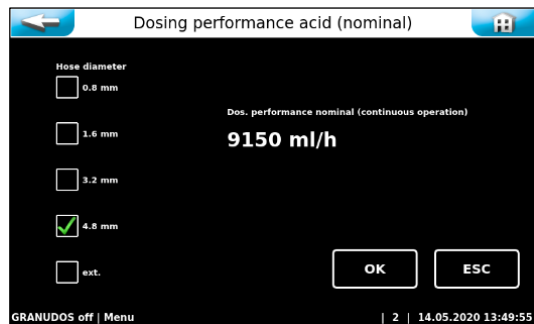

These settings can only be implemented in user level 2. The values set here depend on the dosing device design. They are preset ex works in accordance with the installed components; they are used as the basis for calculating the dosed quantities and the reserve message.

If an **external acid pump** is used, "external" must be checked here and the dosing performance of the external pump must be entered to correctly record the remaining amount in the acid container.







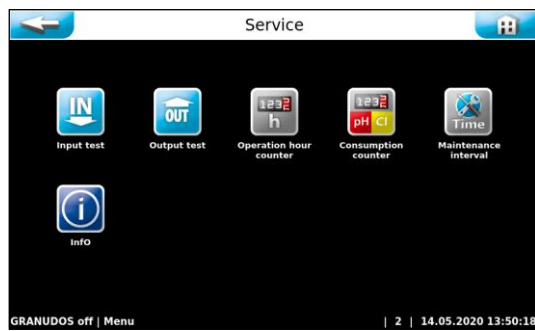

Attention!

It is important that the correct dosing performance is entered; otherwise, incorrect consumption and remaining amounts will be calculated.

6.3.3 Main menu → Service



-  **Input test**
A test programme for switch inputs (electrical signals).
-  **Output test**
A test programme for pumps and relay outputs.
-  **Operation hour counter**
Counts the operating hours for booster pump, feed pump, acid dosing motor, and chlorine dosing motor.
-  **Consumption counter**
Counts the chemical consumption.
-  **Maintenance interval**
Sets time interval for the maintenance message
-  **Info**
For querying the firmware versions.

6.3.3.1 Main menu → Service → Input test

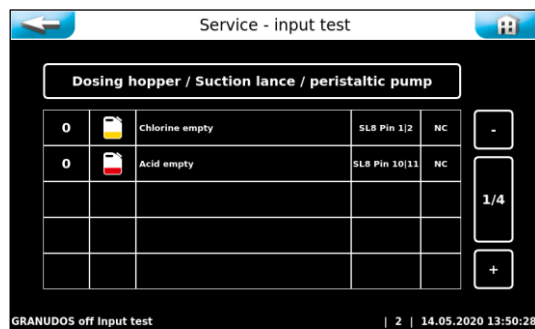

The input test is used for checking the connected inputs (switches). The alternating activation of the switches is indicated by **0 (open) or 1 (closed)** in the column.

The fourth column displays the pin header (SLx) and the connectors (Pinx/x) to which the switch is connected.

The fifth column shows the function of the switches in the operating state.

NO (normally open) indicates open in the operating state and closed in the event of a fault.

NC (normally closed) indicates closed in the operating state and opened in the event of a fault.

You can scroll through the 4 pages for the input test using the + and – buttons.

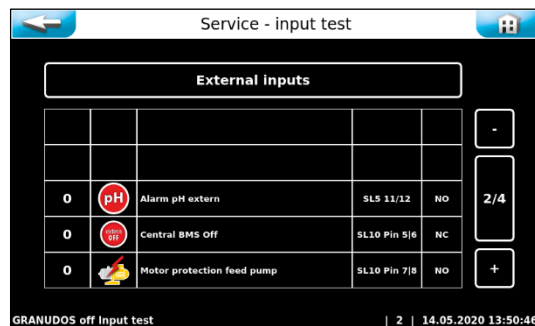

6.3.3.2 Main menu → Service → Output test

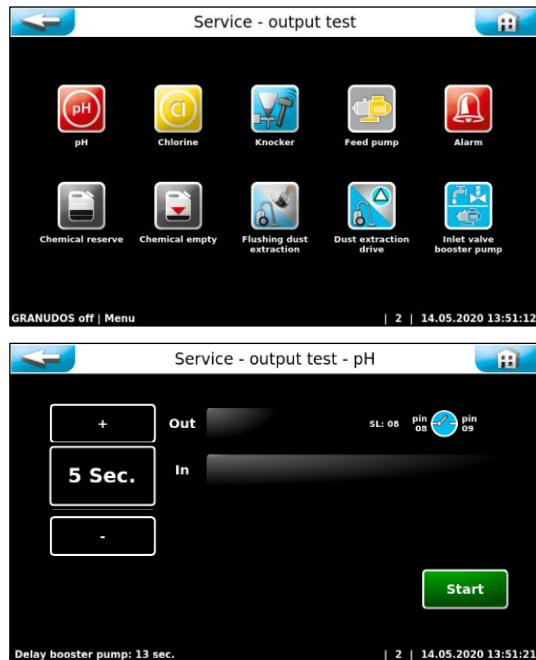

The output tests are used for checking the connected actuators (pumps, motors and relays). The selected output is activated for 5 or 30 seconds. The control can be deactivated at any time using **Stop**.

For safety reasons (generation of chlorine gas), dosing tests can only be conducted if the booster pump is running and no fault exists that could prevent the dosing. That means if the system is stopped, the booster pump is started first.

An output test can be performed for the following actuators:

- pH = acid dosing
- Chlorine dosing
- Knocker
- Feed pump
- Alarm
- Chemical reserve - a joint output for both chemicals
- Chemical empty- a joint output for both chemicals
- Flushing dust extraction
- Dust extraction drive
- Inlet valve booster pump, (*Control valve for the dissolving water*)

6.3.3.3 Main Menu → Service → Operation hour counter

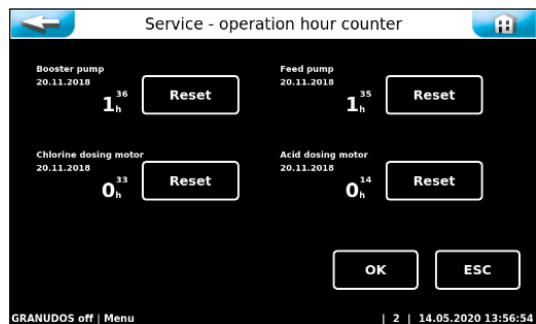

The components entire running times after the last restart are shown here. This is relevant, e.g., during maintenance work or when it is necessary to replace the pump.

These settings can only be implemented in user level 2. Use “Reset” to reset the operating hours for the respective actuators.

6.3.3.4 Main menu → Service → Consumption counter

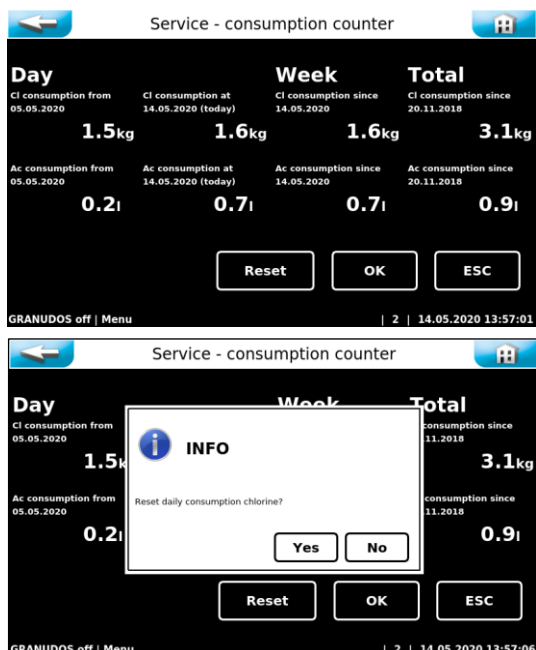

These settings can only be implemented in user level 2.

The consumption counter summarises the consumption of each chemical.

The consumption is calculated on the basis of the chlorine and acid dosing performance determined in Chapter 5.2.11 over the motors' entire running time. If the “Dosing performance determination” is not carried out, the calculation occurs based on the ex-works settings. The reset button can be used to reset each individual consumption reading to 0.

Each value is queried and must be confirmed individually.

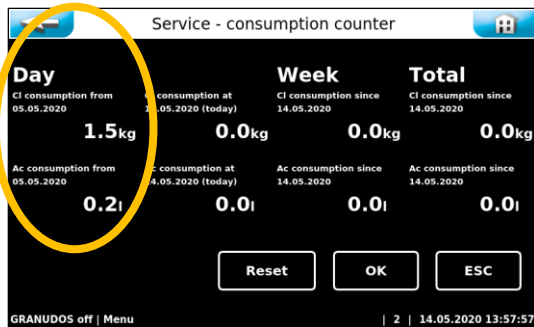

The previous operating day's consumption (left column) cannot be reset.

6.3.3.5 Main menu → Service → Maintenance interval

The time interval for the maintenance message in days is set here. After the set time interval the  symbol is used on the start screen as a reminder of any pending maintenance works.

The blue bar indicates the time that has already elapsed.

6.3.3.6 Main menu → Service → Info

The software and device data used can be viewed using the Info button.

The following are distinguished:

DSP version: → Firmware version

I/O version: → Coprocessor version on the I/O board

HTTP version: → Web front-end version (user interface software version).

Build: → Date of manufacturing

6.3.4 Main menu → Log (event and data logging)



Event Log

Displays a chronological list of the events that have occurred



Data export

Is used to export the collected data to a USB stick



Delete

Is used to delete the stored data



Event Log calibration

Displays a chronological list of the electrode adjustments

6.3.4.1 Main menu → Log → Event Log

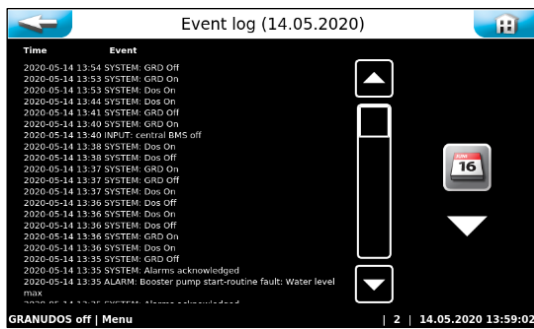

When calling up the menu, a list of events that occurred on this day will be displayed. You can use the Calendar **BUTTON** to view events from previous days.

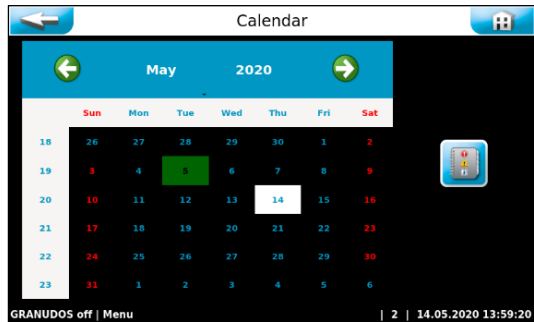

The current day is shown on a white background. Days on which the controller was activated are shown on a green background. If you select another day by touching it, that day will be shown on a white background. You can use the **Event Log** button to view the events of the selected day.

6.3.4.2 Main menu → Log → Data export

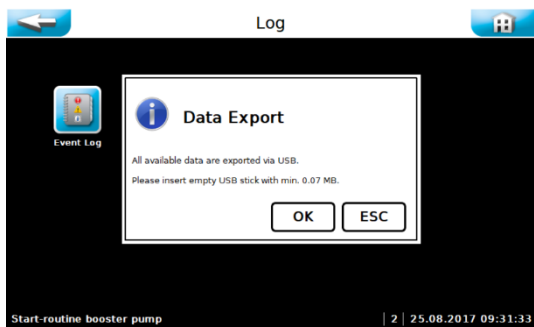

You can use the **Data export** menu item to load the stored log data onto an **empty USB stick**. If the USB stick is not empty, formatting is suggested and will be carried out after you confirm with OK. The USB stick is inserted in the display's backside.

The daily event files and CSV files will then be stored on the USB stick.

6.3.4.3 Main menu → Log → Delete

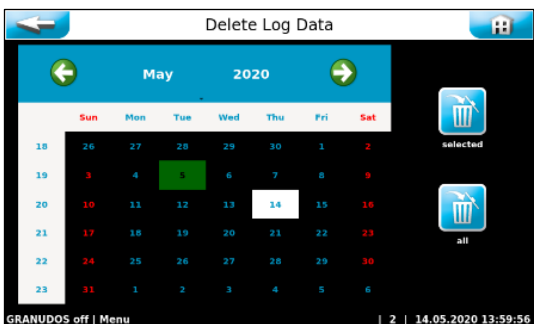

The current day is shown on a white background. Days on which the log files were stored are shown on a green background. If you select the desired day by touching it, that day will be shown on a white background. You can use the **Select button** to delete the event log events and the data log events for the selected day. You can use the **all button** to delete all event log events and data log events at once.

6.3.5 Main menu → Calibration (Optional for design with internal pH Monitoring)

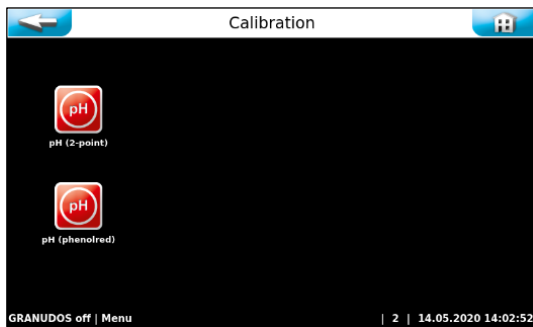

pH (2-point)
Two-point calibration of the pH electrode



pH (phenol red)
One-point calibration of the pH electrode

The calibrations are graphically guided and are accompanied by a help text. Follow the menu prompts. **Confirm** the completed steps **with OK**.



ATTENTION!

During all work on the pH electrode, it must be ensured that neither the electrode's screw plug head nor the plug of the electrode cable are exposed to moisture! Even the smallest amount of moisture in the electrode head may lead to a distortion of the measuring value or even to a failure of the electrode!

All contacts in the electrode's plug head and on the electrode plug must display a shiny golden colour and may not show any signs of corrosion.

6.3.5.1 Main menu → Calibration → pH (2-point)

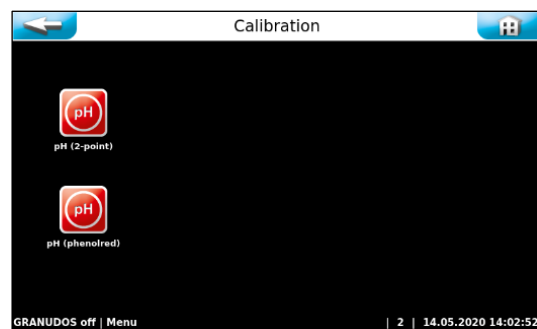

Perform calibration in accordance with the instructions.

pH7 = buffer solution for determining offset voltage.
The optimal offset voltage is at 0mV up to +/-30mV.

pH4 = second buffer solution for determining conductance voltage.

Inclination mV/pH = conductance voltage
The optimal conductance voltage at 25°C is approx. 59mV/pH.
(pH7 – pH4 = 3pH x 59 mV = 177 mV)

Example:
(mV(pH4) = 187 mV – mV(pH7) = 10 mV) = 177 mV ./ 3 pH = 59 mV/pH

Once the pH calibration has been completed, the measuring results for the offset voltage and conductance voltage are displayed and an evaluation of the electrodes is carried out

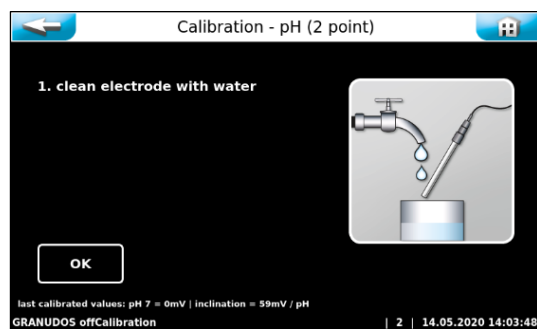

NOTICE!

Notice regarding the evaluation of the electrodes

Cleaning notice

If the **offset voltage** shows a deviation of less than +/-41 mV, the voltage rating will appear in yellow and the calibration will be terminated with a cleaning notice.

If the **conductance voltage** lies between 52 mV/pH and 63 mV/pH, the voltage rating will appear in yellow and the calibration will be terminated with a cleaning notice.

Error notice

If the **offset voltage** shows a deviation greater than +/-61 mV, the voltage rating will appear in red and the calibration will be rejected with an error notice!

If the **conductance voltage** is less than 50 mV/pH or greater than 65 mV/pH, the voltage rating will appear in red and the calibration will be rejected with an error notice!

If the calibration is rejected with an error notice, the device continues the regulation using the values from the most recent successful calibration.

If the exchange of the electrode does not remedy the problem, the fault may be with the electrode cable or the measuring amplifier.

6.3.5.2 Main menu → Calibration → pH phenol red

Notice regarding the phenol red calibration

A two-point calibration of the pH electrode voids the last calibration with phenol red.

Please note that the pH measurement with phenol red can show an error of +/- 0.1 - 0.2 pH.

In addition, the buffer solution is subject to an ageing process and may therefore return additional false values!

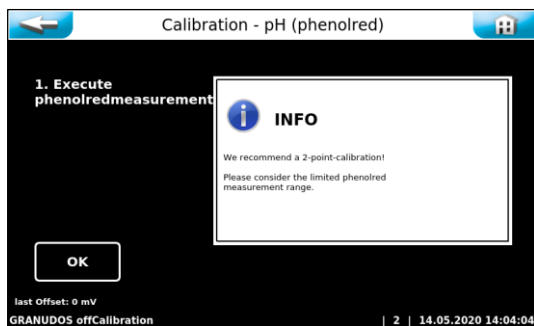

Perform the calibration in accordance with the instructions.

Observe the displayed notices. Follow the menu prompts.

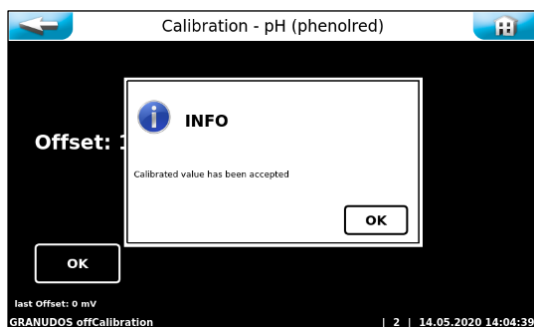

The set deviation is displayed as offset at the end of the menu. In case of minor deviations, the calibration is adopted immediately.

For deviations greater than +/- 41mV a cleaning notice is given.

For deviations greater than +/- 61mV a change of the pH electrode will be suggested. If the calibration is rejected with an error notice, the device continues the regulation using the values from the most recent successful calibration.

If the exchange of the electrode does not remedy the problem, the fault may be with the electrode cable or the measuring amplifier.



Notice:

The calibration of the pH electrode with phenol red must be carried out with water from the swimming pool. The chlorine solution in the buffer tank would destroy the colouring agent in the phenol drops / tablet, thereby falsifying the measurement.

6.4 Calibration of external pH Monitoring (type NE)



For calibration and operation, see separate instructions

6.5 Replenish consumables



PROTECTIVE CLOTHING!

Personal safety equipment must be used when handling chemicals: Tight-sealing goggles, protective gloves, apron, face protection, boots

The safety data sheets for each chemical must be observed.

Replenish acid

Replacing the acid canister, see *Chapter 5.2.2, Prepare acid dosing for operation.*

The specifications for each chemical listed in the safety data sheets must be observed!

Replenish chlorine granulate

Replacing the chlorine granulate, see *Chapter 5.2.3, Attach/change the drum.*

7 Maintenance, care, faults

7.1 Device maintenance

We recommend that you assign a specialist firm to carry out regular maintenance.

To ensure the proper function of the GRANUDOS dosing system, observe the following points:



DANGER DUE TO ELECTRICAL VOLTAGE!

Before any electrical works are carried out, the device must be disconnected from the power supply and secured against being reactivated!

All electrical work on the device must only be carried out by trained specialists in accordance with the applicable safety regulations!

Open and close the casing: see *Chapter 4.5.1, page 28*



Tip!

The maintenance work required for trouble-free operation is listed in the maintenance protocol in *Chapter 9.5*. These tasks should be documented in the maintenance protocol as proof of work.

7.1.1 Clean the dirt filter

When working on lines that carry water, always close the inlet and outlet valves!



ATTENTION!

A clean dirt filter is important for proper functioning. A dirty filter can lead to cavitation in the pump, leading to a reduced performance and bearing damages. It is essential that you clean the dirt filter outside of the GRANUDOS.

Cleaning the dirt filter (Pos. 55, Figure 5, page 12):

- Unscrew the upper d75 and lower d25 screw connections at the filter and completely remove the filter from its bracket.
- Pull out the filter insert.
- Clean the filter insert and the filter hood under running water.
- Reinstall the filter in the reverse sequence.

7.1.2 Replacing the dosing screw and the dust gasket

Deinstallation / installation of the protective cover

- a) Push the dust protection pipe (11) downward.
- b) Loosen the spring bolt (09) of the turning device and rotate the turning device with the drum clockwise from the dosing position upward; while doing so, keep the dosing pipe covered with a finger to prevent any granulate from escaping. Relock the turning device.
- c) Loosen the safety belt (03).
- d) Unscrew the attachment screws of the protective cover, remove the cover - pull the cables slightly inward to ensure improved cover mobility
- e) To install the protective cover, follow the procedure in reverse sequence



PROTECTIVE CLOTHING!

Personal safety equipment must be put on prior to starting the work

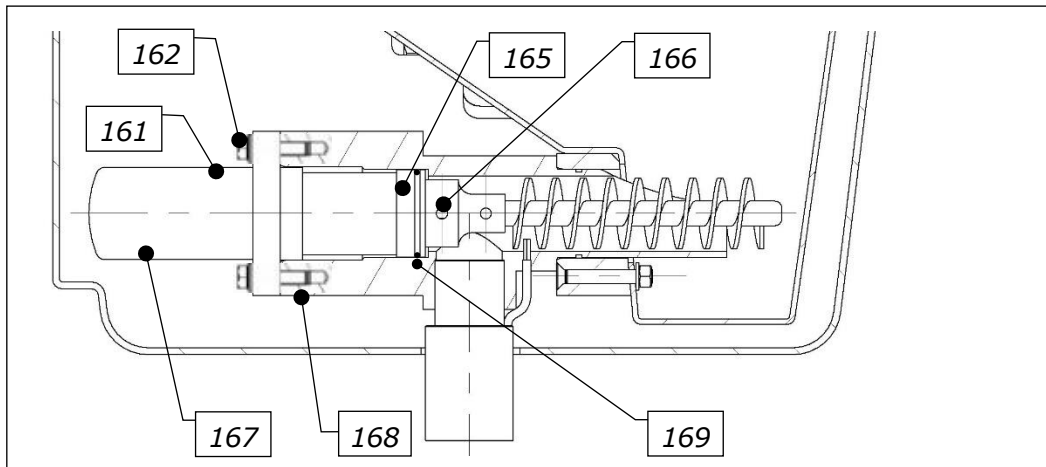

Figure 37, Dosing motor with dosing screw

- | | |
|----------------------------|---------------------|
| 161. Protective cap | 165. Dust cap |
| 162. Screw M5x20 | 166. Headless screw |
| 163. Membrane (covered) | 167. Dosing motor |
| 164. Felt washer (covered) | 168. Motor bracket |
| | 169. O-ring |

Required tools for replacing the dosing screw or the dosing motor

- Phillips screwdriver PZ2 to unscrew the screws in the cover and controller
- Flat-head screwdriver 2mm to loosen the cable clamps,
- Wrench 8mm to loosen the dosing motor
- Measuring device (multimeter) for measuring the voltage
- Small knife or screwdriver to clean the headless screw
- Allen wrench 2.5 mm for the headless screw on the dosing screw

7.1.2.1 Deinstallation of the dosing motor and the dosing screw

- Swivel the drum upward and lock it
- Unscrew the attachment screws of the protective cover, remove the cover - pull the cables slightly inward to ensure improved cover mobility
- Open the connection socket at the dosing hopper if the motor shall be uninstalled.
- Remove the protective caps (161) from the attachment screws M5x20 (162) and unscrew the screws using a key SW 8,
- Pull the motor with the dosing screw from the motor bracket (168) - to do so, hold a flat collection tub (or your hand) under the motor bracket to avoid scattering any chlorine granulate. Clean the inside of the motor bracket and remove scattered chlorine grains.
- Clean the dosing screw - Is the chlorine granulate inside the screw heavily solidified or does the granulate easily scatter from the screw when the latter is pulled out?
- If the granulate is solidified, it may be too moist or have an excessive dust content. It is also possible that the screw is too worn and the granulate is no longer transported properly.

7.1.2.2 Maintenance of the dosing motor

- Disconnect the motor cable at the hopper and pull the cable from the grommet.
- Use a small screwdriver, knife, etc., to scrape the putty from the thread hole of the headless screw (166) on the dosing screw's PVC collar.
- Unscrew the attachment screw with an Allen wrench SW 2.5 and pull the dosing screw from the shaft.
- Pull the dust cap from the dosing motor and remove the old sealing washers.
- Spread silicon grease on both sides of the new felt washer.
- Fill the bearing indentations at the dosing motor with silicon grease.
- First push the sealing washer EPDM (rubber) on the shaft, followed by the greased felt washer, and firmly reattach the dust cap (165) on the motor.

- h) Remove the old O-ring (169) from the dust cap's groove, insert a new O-ring, and apply approx. 2 layers of Teflon tape.
- i) Spread silicon grease on the front surfaces of the dosing motor/PVC dust cap and the dosing screw.
- j) Push the dosing screw on the shaft so that the headless screw (166) is located on the flat part of the motor shaft.
- k) Press the dosing screw against the motor and lightly fasten the headless screw.



ATTENTION!

Do not fasten too tightly, as this may strip the PVC thread.

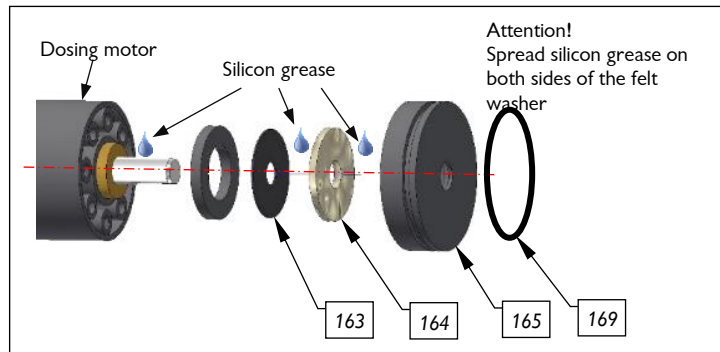

163. Membrane
164. Felt washer
165. Dust cap
169. O-ring

Figure 38, Dosing motor

- l) Thoroughly close the thread bore with putty.
- m) Insert cable in the connection socket - apply a small amount of silicon grease, if needed, and connect the cables: white on white, brown on brown
- n) Test the dosing motor's functioning with the output test
- o) Push the dosing motor into the - cleaned - motor bracket and evenly screw tight with the new screws M5x20. Attach protective caps.



ATTENTION!

Without putty, the headless screw will heavily corrode within a short time and can no longer be unscrewed. If the dosing screw or the motor must be replaced again at a later time, both parts would have to be replaced together!

7.1.2.3 Only replace the dosing motor

Dismantling the motor according to 7.1.2.1

- a) Entirely unscrew the threaded pin from the old dosing screw and insert a new threaded pin.
- b) Clean the front surface of the old dosing screw's adapter and apply a layer of silicon grease.
- c) Open the connection socket at the dosing hopper.
- d) Loosen the connectors of the dosing motor cable (brown - white).
- e) Pull in a new motor cable and clamp tight: brown on brown, white on white.
- f) Push the dosing screw on the shaft so that the threaded pin is located on the flat part of the motor shaft, press firmly against motor and tighten the threaded pin.
- g) Push the motor with dosing screw back into the cleaned bracket.
- h) Screw on the flange - not too tightly.
- i) Press the protective caps on the screw heads.
- j) Place a new O-ring (169) on the dosing screw's guide pipe, wrap with Teflon tape (approx. 3 layers), and apply grease.
- k) Push the dosing unit into the bracket.

7.1.2.4 Only replace the dosing screw

When only replacing the dosing screw, also renew the gasket in the dust protection cap. Sealing washers made of EPDM and felt are included in the scope of delivery.

- a) Pull the dust cap from the dosing motor.
- b) Remove the old gasket from the dust cap.
- c) Thoroughly clean the dosing motor's shaft.
- d) Apply a layer of fresh silicon grease to the ball bearing.
- e) Press a sealing washer 19/4x0,5 EPDM (163) on the shaft.
- f) Thoroughly grease the felt washer (164) and push it on the shaft.
- g) Then push the dust cap (165) over it.
- h) Undo the old Teflon tape and apply approx. 3 layers of new tape.
- i) Apply a layer of silicon grease to the front surface of the new dosing screw's adapter.
- j) Push the dosing screw on the shaft so that the threaded pin is located on the flat part of the motor shaft, press firmly against motor and tighten the threaded pin.
- k) Push the motor with dosing screw back into the cleaned (!) bracket.
- l) Screw on the flange - not too tightly.
- m) Press the protective caps on the screw heads.

7.1.3 Injector with suction pipe and flow switch

Overview

- 45. Injector
- 49. Suction pipe with flow switch (with LED)
- 171. Diffuser nozzle with installed pinhole aperture
- 172. Union nut for flow switch
- 173. Viton hose to the flushing tub
- 174. Switch body (in the suction pipe)
- 175. Suction pipe
- 176. Screw connection of injector intake
- 177. Screw connection of injector outlet

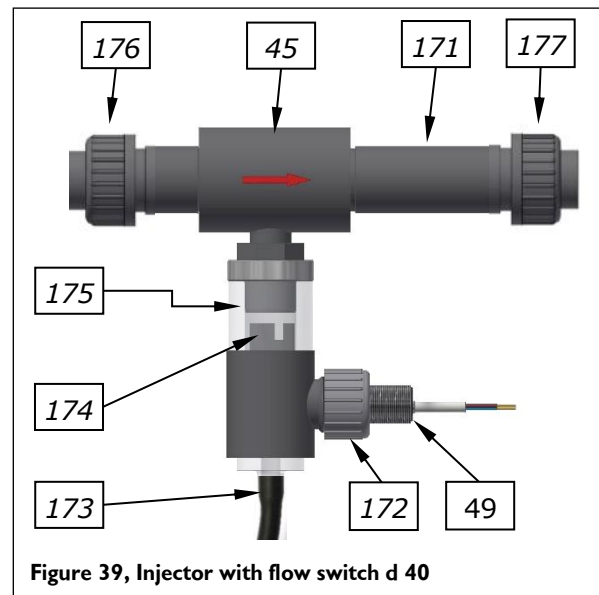

Replace the pinhole aperture:

Unscrew the union nuts (176 + 177) and swivel the injector out. The pinhole aperture is sealed into the O-ring at the diffuser nozzle's (171) inner thread (177). Pry out this pinhole aperture using a small screwdriver. Insert another pinhole aperture or leave the washer out, as needed.

7.1.4 Maintenance and setting of the float control valve for the flushing tub intake

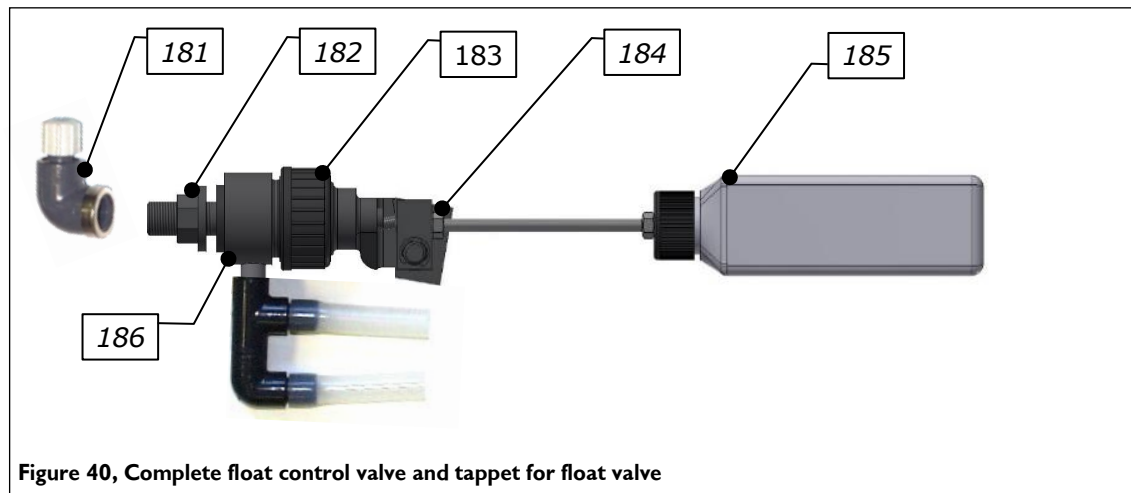

Overview of complete float valve

- 181. Connecting angle 3/8" for flushing water hose 6x1 mm
- 182. 3/8" nut
- 183. Union nut for float assembly
- 184. Adjustment screw for water level
- 185. Float 250ml
- 186. Float valve body with gasket

Overview of tappet for float valve

- 187. Tappet
- 188. Membrane
- 189. Valve cone with O-ring

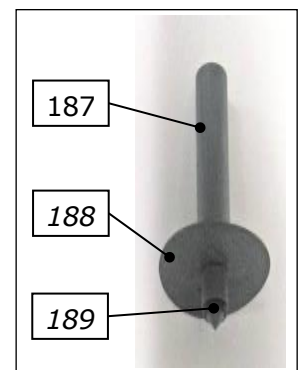

Replace the membrane

- a) Unscrew the union nut (183) and remove the upper part of the float valve.
- b) Remove the tappet assembly (187 to 189).
- c) Pull the valve cone (189) out of the tappet (187).
- d) Push a new membrane (188) onto the valve cone.
- e) Replace the O-ring on the valve cone (189) as well.
- f) Reinstall in the reverse sequence.
- g) Reset the water level in the flushing tub. See Chapter 5.2.7.

7.1.5 Replace and set the Chlorine empty switch at the dosing hopper

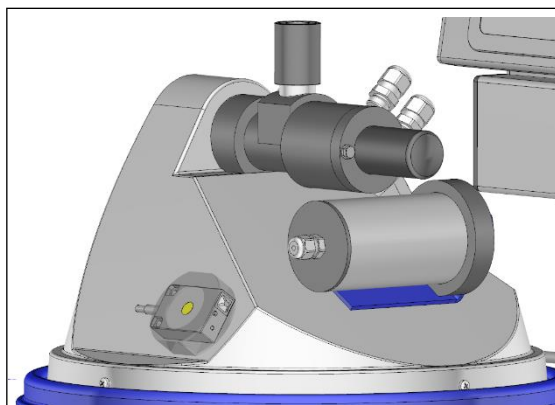

Figure 41, Empty switch for GR 45/100

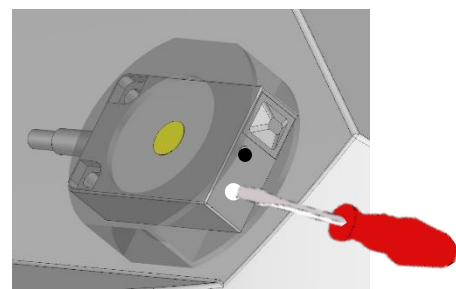

Figure 42, Empty switch installed on GR 45/100

At the GRANUDOS, the empty switch can be accessed after removing the protective cover. The small adjustment screw with the switch LED can be seen on top of the narrow side. When the drum is empty or the dosing hopper with the drum has been turned upward, this LED must **not** be illuminated; the display must show **Chlorine empty**.

If the switch LED is illuminated, turn the adjustment screw slowly to the left until the LED light goes out. The **Chlorine empty** fault display at the controller reacts with a **6-second delay**.
If the switch does not react to the adjustment potentiometer or if the adjustment screw has been destroyed, a new switch must be installed.

Adjust the empty switch (drum rotated upward)

Turn the adjustment screw to the right until the switch LED is illuminated
Then carefully turn it back until the switch LED goes out, followed by an additional 10° turn
The **Chlorine empty** fault is displayed at the controller. After rotating a drum that is **not empty** into the dosing position, the fault indication at the controller goes out - provided there is chlorine in the drum.

Replace empty switch

- Open the connection socket and undo the 3 switch wires, pull out the cable.
- Push the old switch out of the bracket.
- Push the new switch into the bracket until it snaps into place.
- Insert the cable in the connection socket and clamp on according to the wiring diagram.
- Close the terminal casing and fill the screw heads with grease to prevent any corrosion.
- Adjust the switch, as described above.

7.1.6 Calibration of the “No chlorine switch” on the dissolve cyclone



Tip!



The **No chlorine switch** is preset ex works and must only be recalibrated in case of a malfunction. The **LED** on the **No chlorine switch** and the adjustment screw become visible when the protective cap of the **No chlorine switch (51)** is removed. **Without chlorine in the cyclone (50), the LED on the No chlorine switch should not be illuminated!**

The calibration is only possible when “Buffer tank filling” is activated.

The No chlorine switch is installed at the Dissolving cyclone (50). After the start of the 2nd dosing cycle, within 8 seconds the red LED at the No chlorine switch must be continuously illuminated for at least 2 seconds due

to registering the rotating chlorine. Otherwise, a fault indication  is displayed and the GRANUDOS PLUS switches off.

Calibration:

- Deactivate the alarm relay  and/or start the GRANUDOS PLUS:
- Then switch off the dosing ; the GRANUDOS PLUS now only transports water into the buffer tank.
- Wait until no more granulate can be seen in the cyclone.
- Turn the yellow adjustment screw at the sensor in a clockwise direction until the red LED on the sensor is illuminated.
- Then slowly turn it back until the LED goes out again; at this point, stop immediately.
- The sensor is now recalibrated.
- Switch on the dosing .

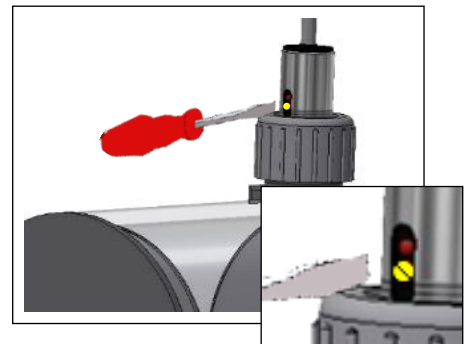

Figure 43, No chlorine switch

7.1.7 Replace the dosing hose of the acid dosing pump

The pump hose in the pump is subject to mechanical and chemical stresses. Therefore, the pump hose must be checked at regular intervals; it should be exchanged annually, see maintenance protocol

Individual components of the peristaltic pump

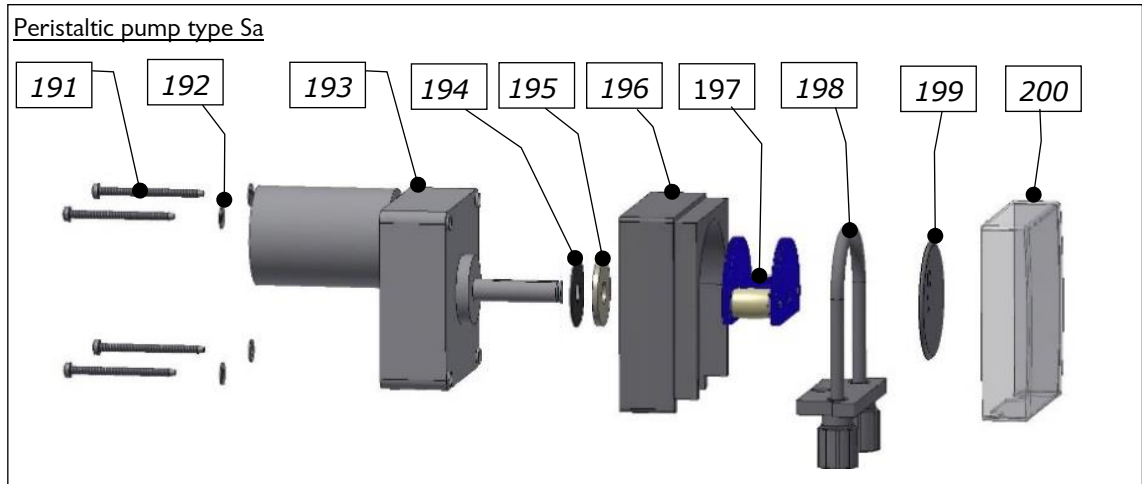

Figure 44, Individual components of the peristaltic pump

Key:

- | | |
|--------------------------|------------------------------------|
| 191. Screw | 196. Pump housing |
| 192. Washer | 197. Roller carrier |
| 193. Gear motor | 198. Hose bracket with dosing hose |
| 194. Sealing washer EPDM | 199. Lock washer |
| 195. Felt washer | 200. Transparent protective cover |



ATTENTION!

The new hose must be of the same colour and size as the disassembled hose. The hose must not be twisted when inserted! The markings on the hose must be centred at the front (see image below).

Replace pump hose on the hose bracket:

1. Disassemble the hose set, see *Chapter 5.2.1, Installation of peristaltic pump, Page 30.*
2. To replace the dosing hose, carefully cut the hose clamps with a sharp knife or pliers! Never damage the hose nipples!
3. Slide the new dosing hose onto the hose nipples so that the markings on the hose ends are located in the front! This ensures that the hose is not twisted.
4. Attach the hose ends using the hose clamps and cut off the protruding ends of the hose clamps.
5. Install the hose set, see 5.2.1

Individual components of the hose set

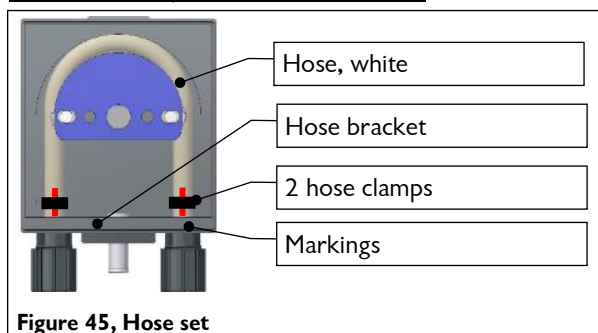

7.1.8 Cleaning the dust extraction (optional)



Tip!

Cleaning: Once the flushing action abates, the **flushing ring** can be dismantled, disassembled and cleaned. Ensure that the original screws are reused, since they are made of a chlorine-resistant material. Using other materials may cause the screws to corrode. This results in rust-coloured stains.

In addition to the tasks from the maintenance protocol, during **each drum exchange** the dust accumulation in the transparent suction hose must be checked and cleaned, if necessary.

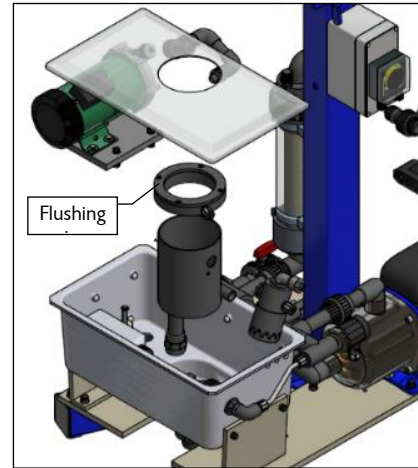

Figure 46, Dust extraction

7.2 pH measurement – calibrate pH electrode (buffer tank)

pH electrodes are wear parts. In the area of swimming pool water treatment, a life span of 6 months to 2 years may be expected.

The contamination of the electrode's diaphragm may be one reason for measuring value deviations. This contamination can usually be cleaned using the electrode cleaner supplied with the delivery.



NOTICE!

After each cleaning or exchange of the electrode, a calibration must be carried out! Do not touch the glass top (sensor part) and the diaphragm with your fingers. Dab the glass top with a clean and soft cloth.

For procedure, see Chapter 6.3.5, page 61

The pH value of the chlorine solution in the buffer tank should be checked regularly (every 2 months).

7.3 Trouble-shooting



Tip!



All faults and notifications are displayed on the touch screen in the IN list. In addition, they may be queried in the Event Log.

An error will only be displayed once it has been pending uninterrupted for at least 6 seconds.









Attention! In the event of a fault indication, it is also possible that switches or sensors are faulty and thus do not transmit any electric signals.













Tip!

Encrustations of chlorine granulate in the dosing hopper can lead to malfunctions. Clean the dosing hopper according to the maintenance protocol.

For fault table, see following page.

Fault display	Cause / effect	Actions
1.  Chlorine empty ALARM: Chlorine granulate container empty	The GRANUDOS stops. The shut-off valve and the booster pump are turned off	1. Refill chlorine granulate, or change container 2. If the chlorine granulate is not empty, recalibrate the empty switch or 3. Renew the empty switch.
2.  Acid empty ALARM: Acid container empty	The GRANUDOS stops The shut-off valve and the booster pump are turned off	1. Replace the empty acid container with a full one 2. If the acid container is not empty, the empty switch is faulty. 3. If the suction lance is new, check the float's functional direction - float at the bottom = empty display; otherwise, turn the float
3.  Filling level reserve chlorine/acid NOTIFICATION:	This notification serves for information purposes only, no action ensues.	Ensure sufficient resupplies.
4.  Minimum pressure ALARM: The flow pressure at the booster pump is too low	The dosing is stopped. The booster pump has been deactivated. 1. Supply pressure too low 2. Booster pump faulty 3. Pressure switch faulty	Check pump Set a lower response pressure at the pressure switch
5.  Flushing tub level minimum ALARM: Water minimum switch active. The water level in the flushing tub is low; more water is suctioned off than runs into the flushing tub through the float valve.	Cause: Inlet pressure too high, Counter-pressure too low The dosing is stopped. The booster pump has been deactivated. Float valve defective? Switch defective?	1. Function of the float valve: The water inlet should gently follow the float's movement. When OK, calibrate the water level. See operating instructions for the dosing unit, <i>Chapter Commissioning 5.2.7</i> . If this is not the case, insert a new membrane in the float valve. 2. Insert a pinhole aperture with a smaller drill hole 3. Dirt filter (Pos.55) contaminated → Clean filter 4. If water level is not at minimum, insert a new switch
6.  Flushing tub level maximum ALARM: Water maximum switch active. The water level in the flushing tub is too high, less water is suctioned off than is flowing into the flushing tub through the float valve.	Cause: Counter-pressure too high Float valve defective The dosing is stopped. The booster pump has been deactivated. Switch defective?	1. If the injector's suction capacity is OK: • Function of the float valve: The water inlet should gently follow the float's movement. When OK, calibrate the water level. See operating instructions for the dosing unit, <i>Chapter Commissioning 5.2.7</i> . If this is not the case, insert a new membrane in the float valve. 2. If the suction capacity is not sufficient, see under fault display " Suction pipe flow minimum ALARM " 3. If water level is not at maximum, insert a new switch
7.  Suction pipe flow minimum ALARM: The water flow in the suction pipe is too low. The switching body of the flow switch does not rise, the switch LED lights up.	The dosing is stopped. The booster pump is stopped.	1. Check booster pump functioning. 2. Dirt filter contaminated → Clean filter 3. Blocked suction opening in the flushing tub 4. There may be particles in the injector, both at the nozzle or in the suction pipe, due to particles entering during assembly or from the chlorine drum 5. Insert a pinhole aperture with a larger drill hole or remove it entirely 6. Blocked non-return valve at the buffer tank 7. Injector's diffuser nozzle worn out, if $D > 6.5$ mm, replace diffuser nozzle
8.  Chlorine dosing monitor in cyclone ALARM: (with buffer tank) The optical sensor on the dissolving cyclone is activated.	The sensor on the cyclone indicates that during the 2nd dosing interval, insufficient chlorine was dosed/is present in the cyclone.	1. Fault during dosing: Clotting in chlorine granulate Dosing screw blocked due to poor chlorine quality (too fine, moist) 2. The dosing motor is defective. 3. Calibrate the optical sensor.

<p>9.  ALARM: Fuse for the chlorine dosing motor or acid dosing motor or supply of the 24V sensors See log file in regard to the differentiation between the individual safeguards</p>	<p>The dosing and booster pump stop</p>	<p>Check chlorine motor for blockages, remove blockage if necessary and renew the fuse.</p> <p>Check the acid dosing motor and renew the fuse.</p> <p>Check the Chlorine empty, check No chlorine Flow minimum sensors; renew the defective sensor and the fuse.</p>
<p>10.  Buffer tank filling start NOTIFICATION:</p>	<p>The filling starts. Booster pump and Control valve for the dissolving water active</p>	<p>The dosing device starts to produce chlorine solution at the set dosing performance.</p>
<p>11.  Buffer tank filling stop NOTIFICATION:</p>	<p>The filling with chlorine solution stops.</p>	<p>The flushing programme starts; afterwards, the programme switches into "Standby"</p>
<p>12.  Buffer tank minimum level ALARM:</p>	<p>The lower control switch for starting the filling did not trigger.</p> <p>Feed pump is switched off</p>	<p>a) Check switch function: If the tank is empty, the switch contact must be closed (measure at the terminal). If open: Switch or terminal contact faulty b) The sum of the flow capacity of all dosing lines is higher than the filling capacity of the GRANUDOS. Increase the chlorine dosing performance at the GRANUDOS</p>
<p>13.  Buffer tank level maximum ALARM:</p>	<p>During the filling process, the upper maximum level control switch for stopping the filling did not trigger. The GRANUDOS switches off. When the control valves are closed, there may be backflow from the dosing lines. When the feed pump is stopped: The feed pump starts in the emergency programme.</p>	<p>a) Check "Stop buffer tank filling level" switch: If the tank is full, the switch contact of the "Stop buffer tank filling level" switch must be closed (measure at the terminal). If it is open when the buffer tank is full, the switch or terminal contact is faulty. If the "Stop buffer tank filling level" switch is working properly: → Check Control valve for the dissolving water for proper function - does not close?</p>
<p>14.  Protection tub level ALARM:</p>	<p>The level switch in the protection tub reports liquid in the protection tub.</p> <p>Causes, see fault indication 13</p> <p>In addition: The GRANUDOS does not switch off if Level maximum alarm also does not react</p>	<p>a) Buffer tank is overflowing or leaking b) "Stop buffer tank filling level" and "Level maximum alarm" level switches at buffer tank defective. → Renew level switches c) Control valve and non-return valve in a dosing line are leaking (when the feed pump is not running) → Renew valves d) Control valve for the dissolving water</p>
<p>15.  CCT (Central Control Technology) OFF, NOTIFICATION:</p>	<p>The dosing device stops</p>	<p>No action, since it has been deactivated externally.</p>
<p>16.  pH Monitoring ALARM: Only active for design with pH monitoring</p> 	<p>1. If the pH value is too high: → Clouded flow meters 2. If the pH value is too low: → The solution has a strong chlorine smell</p>	<p>1. Calibrate pH monitoring 2. If the pH value is high: Check the acid dosing a. Function of the dosing pump/pump relay b. Dosing hose, roller carrier c. Leakage at the suction line d. Dosing valve blocked e. Increase dosing performance for acid 3. If the pH value is low: a. Increase chlorine dosing performance b. Reduce acid dosing</p>
<p>17.  Feed pump motor protection ALARM:</p>	<p>The feed pump's motor protection switch has triggered → The dosing device stops</p>	<p>Check of the pump motor and the electric supply</p>
<p>18. GRANUDOS OFF, check PB start and PB stop ALARM:</p>	<p>The level switches at the buffer tank report "Start filling" and "Stop filling" simultaneously</p>	<p>Both level switches have been triggered, check / renew level switches</p>

Malfunctions without display in the device:

1. The display is dark and the device is turned off:

- No supply voltage: → Restore the supply voltage
- The main fuse at the lower left of the casing has blown: → Renew fuse - determine the cause
- The fuse F1 at the power pack has blown: → Renew fuse - determine the cause
- The power pack is defective: → Renew power pack

2. The flushing tub overflows when shutting down the GRANUDOS: → In this case, check the following parts:

- Leaking float valve: → Renew membrane
- Control valve for the dissolving water does not close: → Check valve
- Non-return valve in the filling line to the buffer tank does not close: → Check non-return valve

3. The device does not save the entered values. (e.g., dosing performance):

- SD card defective → Renew the SD card with original software.

4. Dust extraction (optional)

Error	Cause	Remedy
Suctioning / flushing does not work	Dust extraction pump without function	Check pump function
	Solenoid valve without function	Check solenoid valve function
	Flushing tub empty or pump intake plugged	Check the filling level in the filling basin Check the outlet connection of the flushing tub
Suctioning / flushing limited function	Hose broken or plugged	Visual check of the hose connections; clean, if necessary
	Flushing ring dirty	Clean flushing ring
	Pump draws air or is not properly vented Pump intake dirty or plugged	Check connections Properly vent pump Check intake and clean, if necessary
	Hoses dirty	Check hoses and clean, if necessary
	Solenoid valve, disconnect lever with gasket worn out	Renew disconnect lever with gasket (article 12829)

Switch contact to the corresponding fault indication:

Designation	Situation	Switch contact	Display in the "IN" list
Dosing device			
1. D-min alarm, b-pump flushing tub	no pressure at pump	open	yes
2. W-min alarm, flushing tub	Float at the bottom	closed	yes
3. W-max alarm, flushing tub	Float at the top	closed	yes
4. Df-min alarm, flushing tub	Switch body at the bottom	closed	yes
5. No chlorine alarm	No granulate in the cyclone	open	yes
6. Chlorine empty alarm	No chlorine	open	yes
7. Acid empty, alarm acid container	Float at the bottom	open	yes
Feed system			
8. "Start filling" level. Buffer tank notification	Float at the bottom	closed	yes
9. "Stop filling" level buffer tank notification	Float at the top	closed	yes
10. Level min. alarm, buffer tank	Float at the bottom	closed	yes
11. Level min. alarm, buffer tank	Float at the top	open	yes
12. Level protection tub alarm	Float at the top	closed	yes
13. pH Monitoring alarm	pH value not within the tolerance range	closed	yes
14. Feed pump motor protection alarm	Motor protection switch is triggered	closed	yes
Other			
15. CCT (Central Control Technology) off, notification	Input CCT,	open	yes

8 Decommissioning – Storage – Disposal

8.1 General

In the event of decommissioning or risk of frost, the devices must be emptied completely and protected against frost!

8.2 Decommissioning of the GRANUDOS PLUS dosing device

- a) Remove the suction lances from the acid canister and place it in a bucket filled with clean water. Then start the acid output test.
- b) Dismount the chlorine drum from the GRANUDOS and close it securely
- c) Empty the dosing hopper into the chlorine drum and thoroughly clean it.
- d) Carefully remove any remaining calcium hypochlorite in the device. Open the dosing valves, stop the dosing via the  button and allow the system to run for 2-3 hours without dosing. See also Chapter 8.3
- e) Disassemble the dosing motor with the dosing screw from the dosing hopper, thoroughly clean the dosing motor with the dosing screw and store it in a dry place. **No chlorine grains must be left on the ground!**
- f) Remove the roller carrier from the acid pump in order to relieve the dosing hose.
- g) If there is a risk of frost, drain all of the water-containing parts.
- h) Keep the GRANUDOS activated to prevent potential condensation in the controller casing. (In case of very moist and cold rooms)





ATTENTION!

When recommissioning, it is essential that the instructions in the "Commissioning" chapter are observed and the points contained in the commissioning protocol are implemented.

8.3 Decommissioning the feed system GRANUDOS PLUS / Buffer tank

While the GRANUDOS is running, the feed pump must be in operation and the control valves on the dosing line must be open. This allows the system to be flushed and cleaned.

Procedure:

- a) Start the system with the  button and switch of the dosing with .
- b) Manually open the control valves.
- c) The system will now be flushed with water and residual chemicals will be washed out.

Vacuum the sediment deposits from the buffer tank, if necessary.

Any tightly adhering deposits can be removed with **heavily diluted hydrochloric acid**, if necessary.

ATTENTION CORROSIVE!

Hydrochloric acid is corrosive, wear protective equipment!



8.4 Disposal of used parts and operating materials





First, thoroughly clean disassembled, contaminated parts and dispose of them or have them recycled, in accordance with the regulations applicable at the operating location. Observe the relevant instructions on the packaging for the operating materials. In case of doubt, information may be obtained from the authorities responsible for disposal at your location.

If this is not possible, dispose of the parts/substances as hazardous waste.

9 Documents

9.1 Declaration of conformity

<p>WDT Werner Dosiertechnik GmbH & Co. KG Hettlinger Straße 17 D-86637 Wertingen Tel. 0049 8272 98697-0 Fax 0049 8272 98697-19 info@werner-dosiertechnik.de www.werner-dosiertechnik.de</p>		 Werner Dosiertechnik	
<p>EG-Konformitätserklärung EC declaration of conformity Déclaration de conformité UE</p> <p>im Sinne der EG-Maschinenrichtlinie 2006/42/EG, Anhang II 1.A as defined in the ECMachinery Directive 2006/42 / EC, Annex II, Part 1A selon la directive européenne machines 2006/42 / CE, annexe II 1.A</p>			
Hersteller	WDT - Werner Dosiertechnik GmbH & Co. KG		
Manufacturer	Hettlinger Str. 17		
Fabricant	866637 Wertingen-Geratshofen		
Beschreibung und Identifikation des Produktes:			
Description and identification of the product:			
Description et identification du produit :			
<p>Typenbezeichnung:</p> <ul style="list-style-type: none"> Granudos 10, Granudos 10-CPR Touch, Granudos 10-Touch, Granudos 10-S5 Granudos 15, Granudos 15-PC, Granudos 15-S5 Granudos 45/100-PB, Granudos 45/100-S4, Granudos 45/100 Plus-V70 Touch, Granudos 45/100-CPR Touch, Granudos 45/100-Touch, Granudos 45/100-S5, Granudos 45/100 Plus-V80 Touch Granudos FB 			<p>Art:</p> <p>Maschine</p>
Funktion:	Das Dosiersystem dient zur Desinfektion von Schwimmbadwasser mit Calciumhypochloridgranulat.		
Function:	The dosing system is intended for swimming pool disinfection using calcium hypochlorite granules		
Fonction:	Le système de dosage est utilisé pour la désinfection des piscines avec des granulés d'hypochlorite de calcium		
<p>Es wird ausdrücklich erklärt, dass das Produkt allen einschlägigen Bestimmungen der folgenden EG-Richtlinien entspricht: It is expressly stated that the product complies with all relevant provisions of the following EC directives Il est explicitement dit que le produit est conforme à toutes les dispositions pertinentes des directives CE suivantes :</p>			
2006/42/EG	RICHTLINIE 2006/42/EG DES EUROPÄISCHEN PARLAMENTS UND DES RATES vom 17. Mai 2006 über Maschinen und zur Änderung der Richtlinie 95/16/EG (Neufassung)		
<p>Die folgenden harmonisierten Normen nach Artikel 7 (2) wurden angewandt: The following harmonized standards as defined in Article 7 (2) were applied: Les normes harmonisées suivantes selon l'article 7 (2) ont été appliquées :</p>			
EN ISO 12100:2010	Sicherheit von Maschinen - Allgemeine Gestaltungsleitsätze - Risikobeurteilung und Risikominderung		
EN 60204-1:2006	Sicherheit von Maschinen – Elektrische Ausrüstung von Maschinen – Teil 1: Allgemeine Anforderungen		
EN ISO 14120:2015	Anforderungen an Gestaltung und Bau von feststehenden und beweglich trennenden Schutzeinrichtungen		
<p>Die in der Gemeinschaft ansässige Person, die für die Zusammenstellung der technischen Unterlagen bevollmächtigt ist: The designated person who is authorized to draw up the technical documentation: La personne établie dans la communauté qui est autorisée à constituer le dossier technique:</p>			
Name:	Werner Dosiertechnik GmbH & Co KG		
Straße/Nr.:	Hettlinger Straße 17		
PLZ Stadt:	86637 Wertingen		
Wertingen, 28.01.2020	 Unterschrift/signature Jochen Rieger, Director		
Ort/City/Place, Datum/Date			
			
<p>CE SW 001 Konformitätserklärung Granudos.docx</p>			

9.2 Wiring diagrams



DANGER!

Risk of death due to high voltage. All electrical work on the device must only be carried out by trained specialists in accordance with the applicable safety regulations! Fuses on the control plates must only be renewed once the voltage has been disconnected and secured against being reactivated!



Tip!

These operating instruction contain the wiring diagrams for the devices' standard design. The special wiring diagrams attuned to the optimal furnishing of the dosing device and the GRANUDOS PLUS feed system are located in the devices' terminal boxes.

Dissolving system:

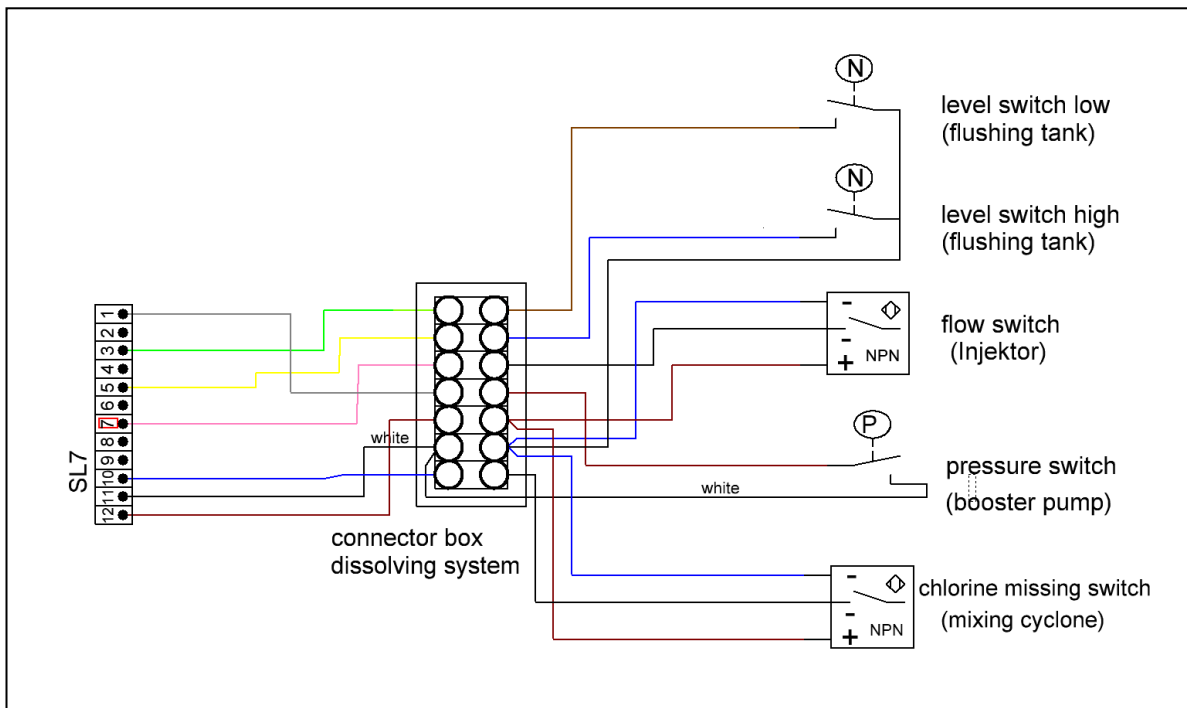

Dosing hopper:

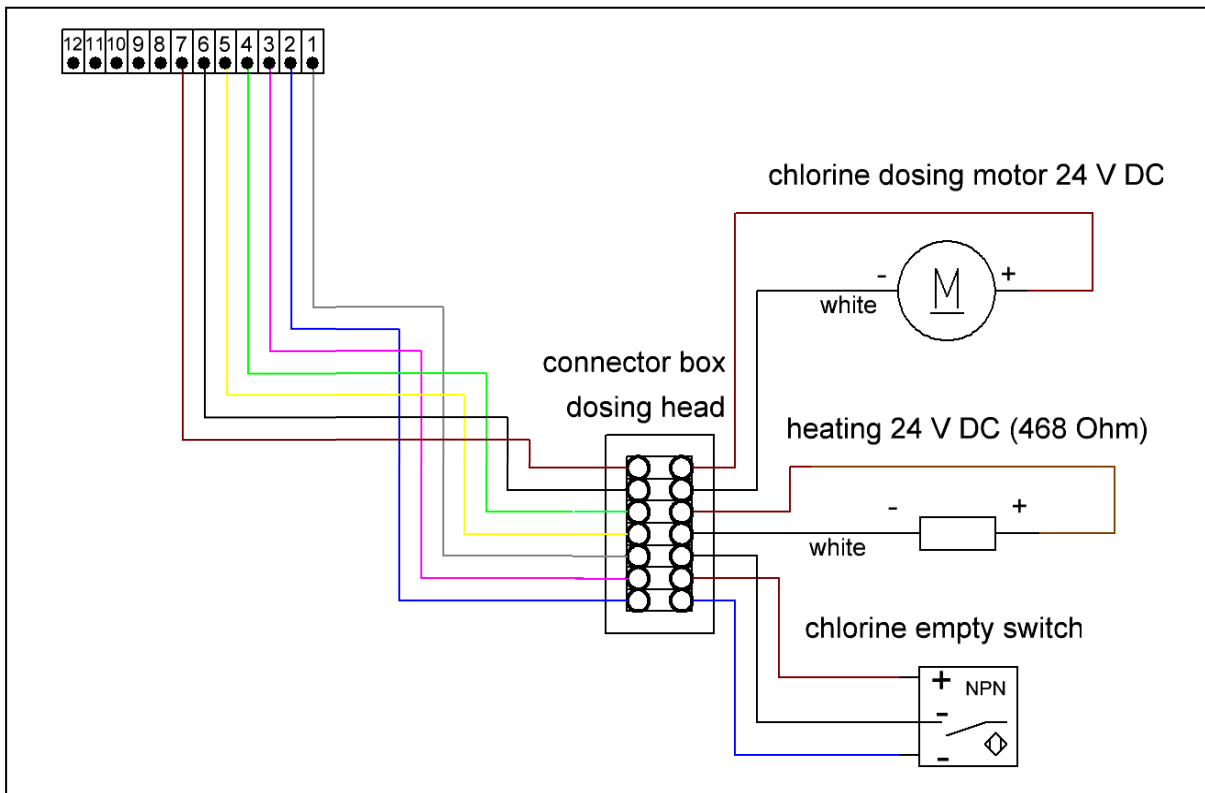

Acid pump:

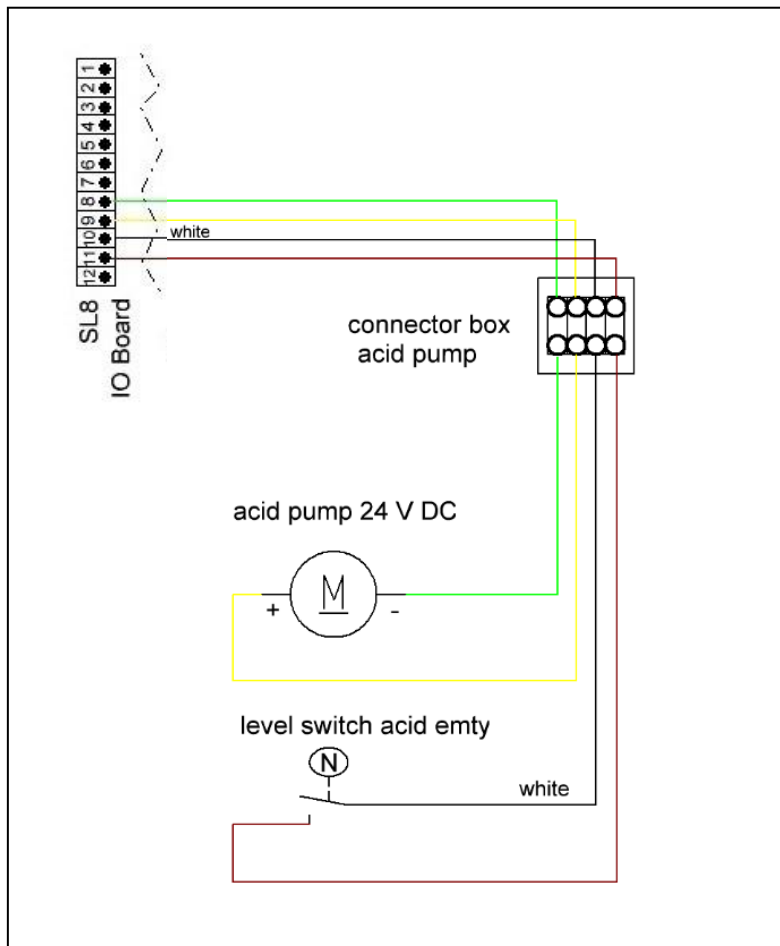

9.2.1 Wiring diagram power pack with connection to the I/O circuit board

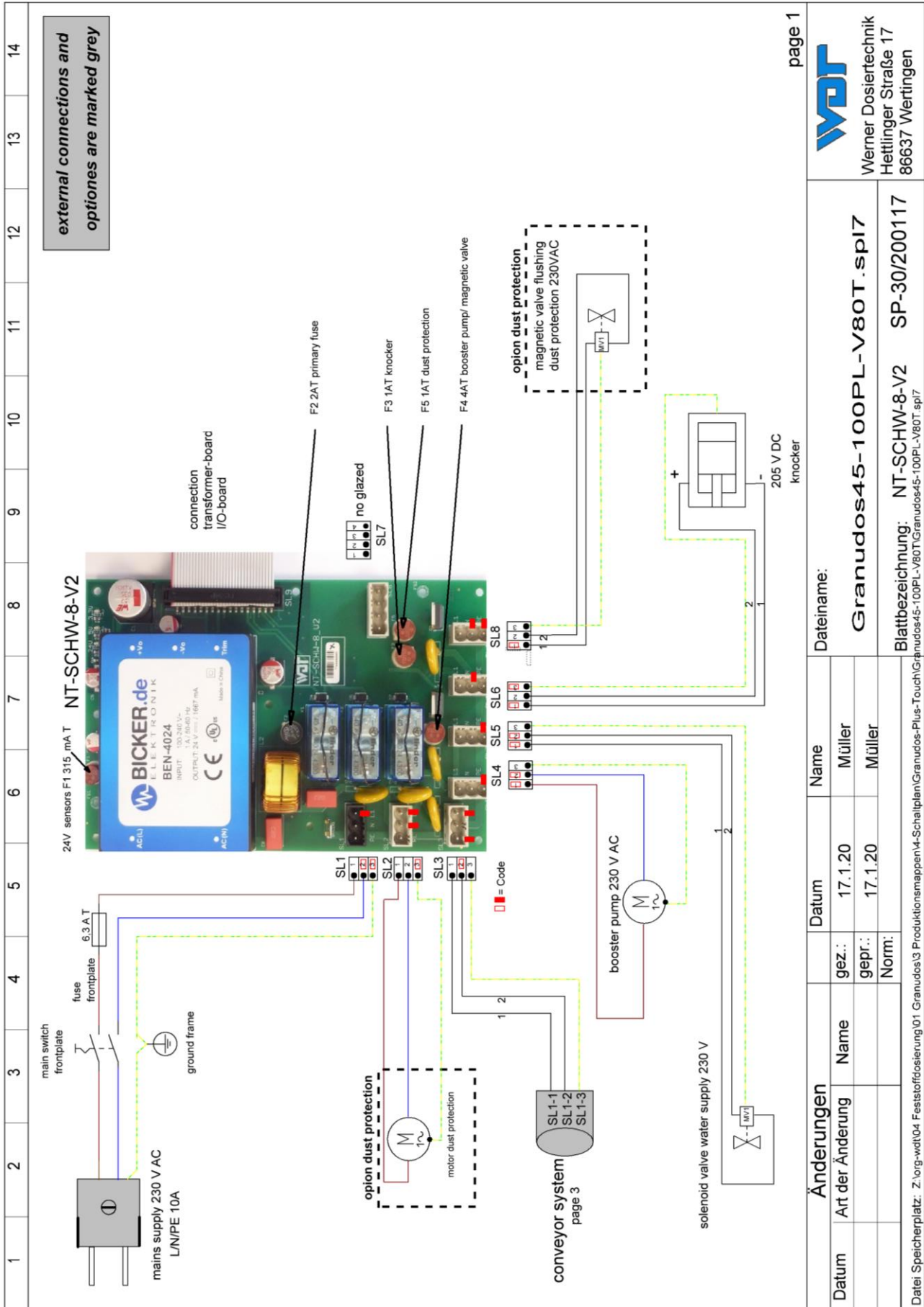

9.2.2 Wiring diagram for I/O circuit board GRANUDOS 45/100 PLUS

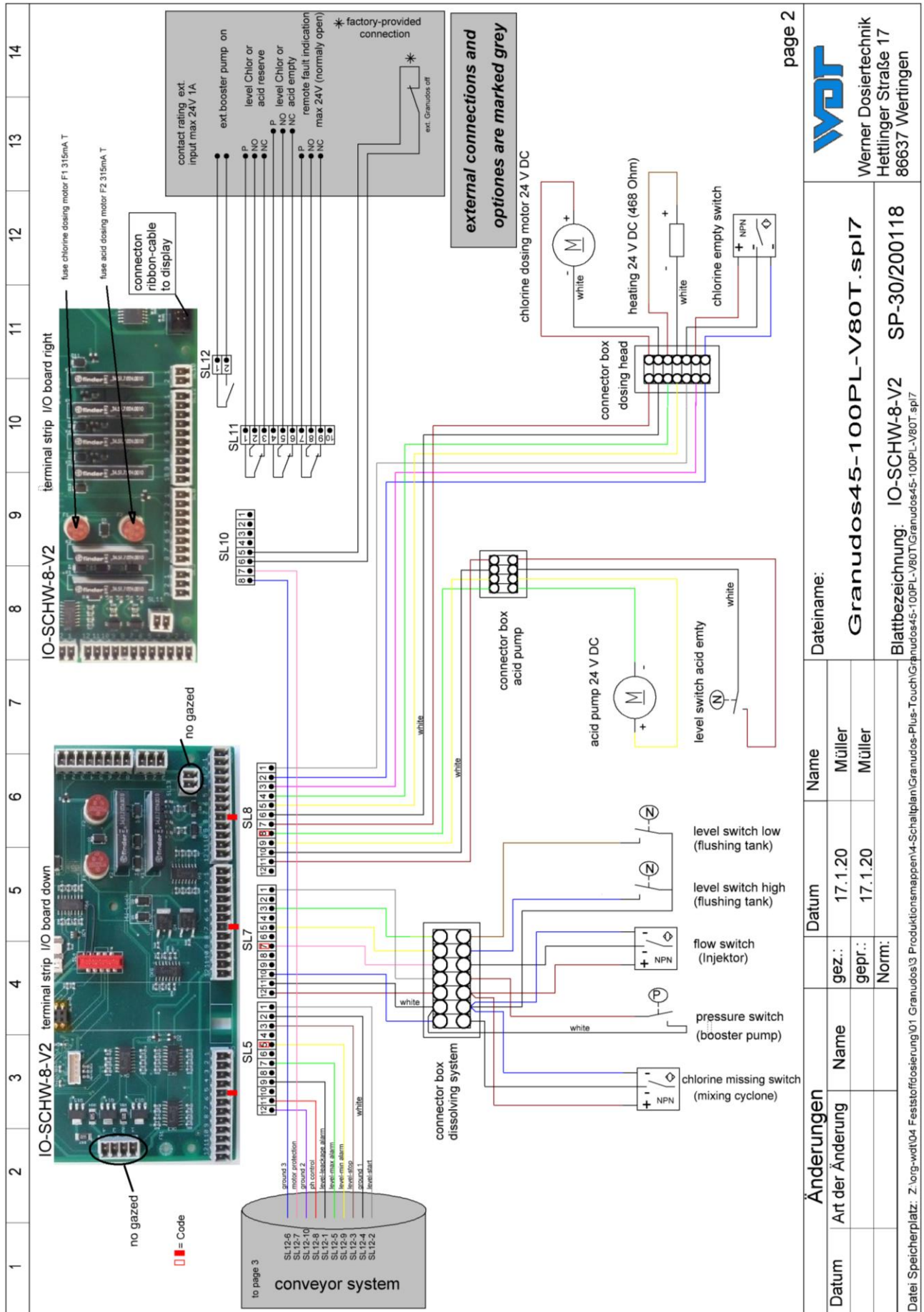

9.2.3 Wiring diagram I/O circuit board SCHW 8 – on-site buffer tank

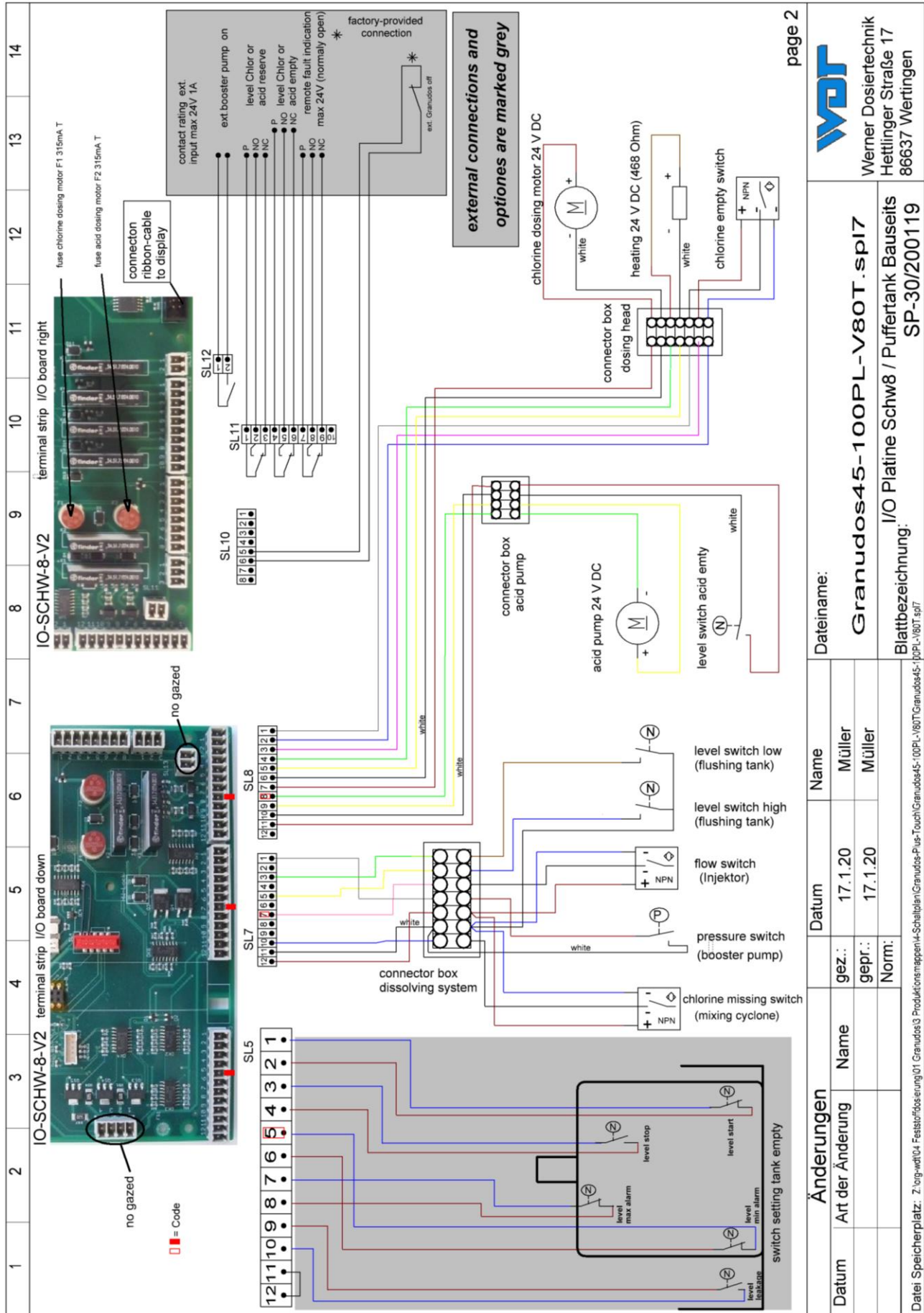





page 2

Änderungen		Dateiname:	
Datum	Art der Änderung	Name	
17.1.20	gez.:	Müller	Granudos45-100PL-V80T.sp17
17.1.20	gepr.:	Müller	
	Norm:		I/O Platine Schw8 / Puffertank Baueits SP-30/200119
Datei Speicherplatz: Z:\big-wdt\U4_Feststoffdosierung\01_Granudos 03_Produktionsmappen\4-Schaltplan\Granudos-P-use-Touch\Granudos-45-100PL-V80T\Granudos45-100PL-V80T.sp17			

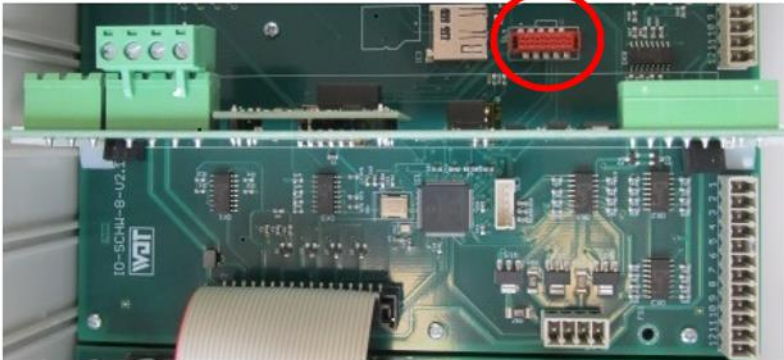
WDT
Werner Dosiertechnik
Hettlinger Straße 17
86637 Wertingen

9.2.4 Wiring diagram pH monitoring

1	2	3	4	5	6	7	8	9	10	11	12	13	14		
<p>Messverstärkerplatine</p> 				<p style="text-align: center;">Transparent Schwarz/Schimm</p> 				 <p style="text-align: right;">pH-Elektrode 10933</p>				<p style="text-align: center;">Ablauf bei einer Nachrüstung</p> <ul style="list-style-type: none"> - Die beiden weißen Halter in die IO-Platine einrasten - Messverstärkerplatine in die Stecksocket einschieben - Eventuell vorhanden Brückenstecker (rot) entfernen - pH-Kabel über Kabelverschraubung in das Gehäuse einführen und wie abgebildet anschließen - pH-Überwachung in den Softwareeinstellungen aktivieren - pH-Elektrode justieren (mit Pufferlösungen pH7+pH4 im Menüpunkt Justieren 2-punkt) 			
							<p style="text-align: center;">Bitte beachten!</p> <p>Wenn ein Messverstärker auf eine IO-SCHW8 Platine gesteckt wird, muss ein eventuell vorhandener roter Stecker mit Drahtbrücke aus dem Socket entfernt werden.</p>								
Dateiname: pH-Überwachung-SCHW8-intern.sp17															
Blattbezeichnung: Messverstärker SP-30/210419															
 <p style="text-align: right;">Werner Dosiertechnik Hettlinger Straße 17 86637 Wertingen</p>															
Änderungen				Datum		Name		Dateiname:							
Datum		Art der Änderung		Name		Name		pH-Überwachung-SCHW8-intern.sp17							
				gez.: 19.04.2021		Kapeller									
				gepr.: 19.04.2021		Kapeller									
				Norm:											
Datei Speicherplatz: Z:\org\wdf\l\Freistellösung\01_Granudos\3_Produktionsmappen\4-Schaltpläne\Granudos-Plus-Touch\pH-Überwachung-intern\pH-Überwachung-SCHW8-intern.sp17															

9.2.5 Wiring diagram Feed system 230V FU (Pump MPN130 FU)

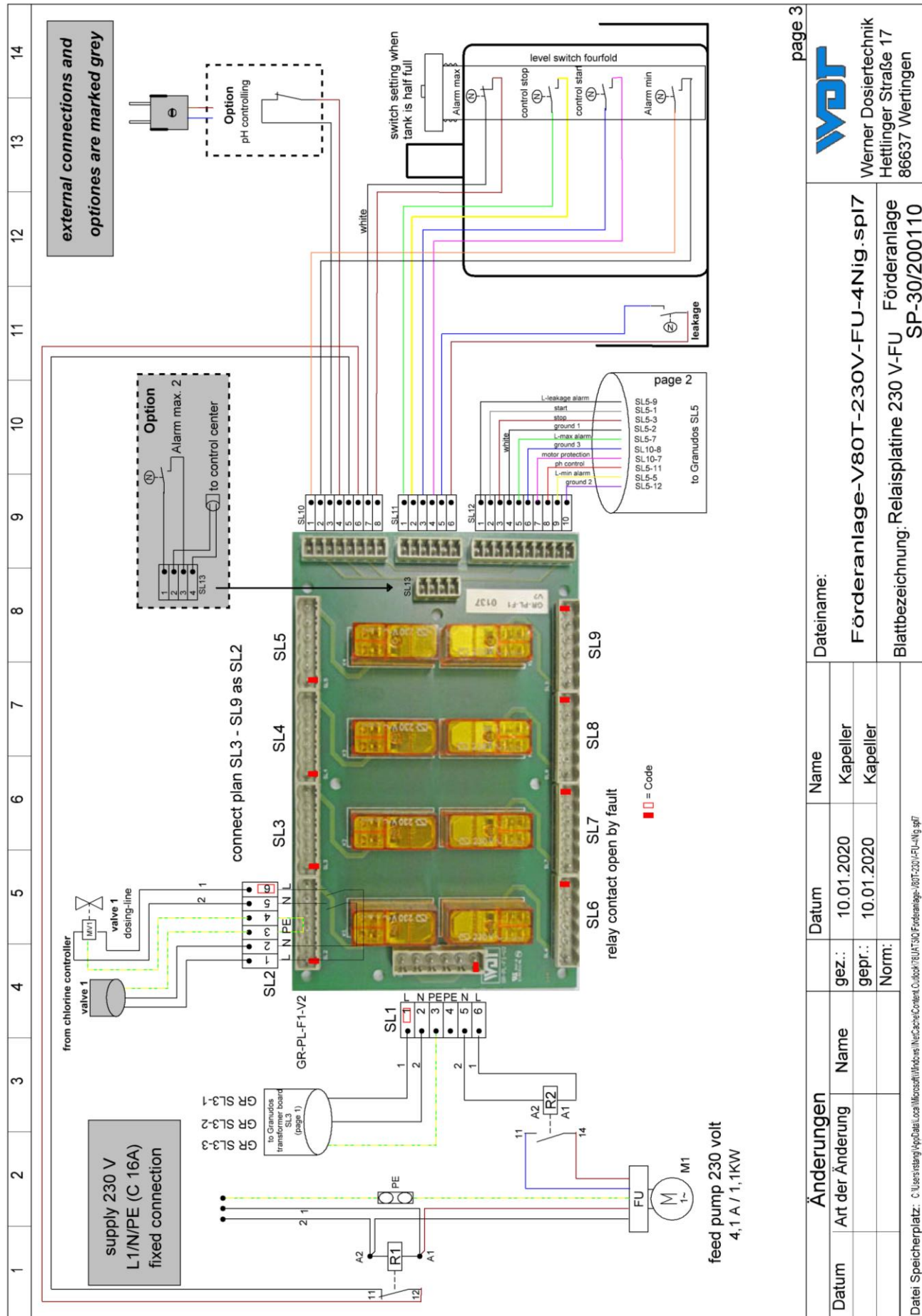

Änderungen		Datum	Name
Datum	Art der Änderung	gez.:	Name
		gepr.:	Kapeller
		Norm:	Kapeller

Dateiname: **Förderanlage-V80T-230V-FU-4Nig.sp17**

Blattbezeichnung: **Relaisplatine 230 V-FU Förderanlage SP-30/200110**

Werner Dosierttechnik
Hettinger Straße 17
86637 Wertingen

page 3

9.3 Commissioning protocol

The commissioning protocol is included with the attached documents.

9.4 Operation data sheet



During a *programme exchange*, all parameters are reset to the ex-works settings. After a programme exchange, all parameters must therefore be checked and readjusted. We therefore recommend that you enter the optimised, basin-specific parameters in this list.

Settings menu	Ex works setting	Setting ranges	Step	during commissioning	Optimised during operation
				Date:	Date:
1 Dosing performance					
Acid	75%	10 – 100%	1		
Calcium hypochlorite	75%	50 – 100%	1		
Cycle time	30 seconds	—		—	—
Pressure switch (41)	1.5 barg	1 – 3 barg	0.25		
2 Reserve indication chlorine					
Reserve message	after task	1-150 kg	1		
Drum size	after task	10-150 kg	1		
Reserve indication	On	Off - On			
3 Reserve indication acid					
Reserve message after	20l	1-500l	1		
Canister size	25l	1-500l	1		
Reserve indication	On	Off - On			
4 System					
Date/ time	CET / CEST	CET -12 +11			
Display brightness	80%	9 - 100%	1		
System variant	after task	with / without feed system			
5 System → Password					
End user	—	0000 – 9999	1		
Technician 1	01234	00000 – 99999	1		
6 System → Display					
Screensaver	20%	12-100%	2		
Delay screen saver	00: 05	00: 00 – 23: 59h			
Backlight	75%	24 - 100%	2		
7 System network (if available)					
IP-address	—	xxx.xxx.xx.x			
Subnetmask	—	xxx.xxx.xxx.x			
Gateway	—	xxx.xxx.xx.x			
8 Dosing performance determination					
1. Dosing sample		Weight:			
2. Dosing sample		Weight:			
3. Dosing sample		Weight:			
9 Dust extraction					
Flushing interval	12h	0 – 48h	1		
Flushing time	5 seconds	0 - 5 seconds	1		
Dust extraction	after task	Off – On			

10 Buffer tank/feed system (optional)					
Dosing performance line 1	—	Adjustment at the valve			
Dosing performance line 2	—	5-1000 l/h			
Dosing performance line 3	—	5-1000 l/h			
Dosing performance line 4	—	5-1000 l/h			
Dosing performance line 5	—	5-1000 l/h			
Dosing performance line 6	—	5-1000 l/h			
Dosing performance line 7	—	5-1000 l/h			
Adjustment pressure retention valve	1.2 barg				
11 pH Monitoring (optional)					
ON/OFF	after task	Off – On			
Setpoint	6.8 – 7.2pH				
Alarm low	6.5pH				
Alarm high	7.5pH				
Time delay	5 minutes				
Measurement internal / external	after task	Internal / external			
12 Delay Booster pump					
Delay time	20	0 - 120 sec	5		
13 Dosing performance Chlorine granulate					
RPM dosing screw	after task	12 – 60 rpm	1		
Diameter dosing screw	after task	19 / 26mm	1		
14 Dosing performance ac					
Hose diameter	4.8mm	0.8/1.6/3.2/4.8/ext			
15 Maintenance interval					
Maintenance after	365 days	0 – 365 days			

Operation data sheet, –master copy–

Settings menu	Ex works setting	Setting ranges	Step	during commissioning	Optimised during operation
				Date:	Date:
1 Dosing performance					
Acid	75%	10 – 100%	1		
Calcium hypochlorite	75%	50 – 100%	1		
Cycle time	30 seconds	—		—	—
Pressure switch (41)	1.5 barg	1 – 3 barg	0.25		
2 Reserve indication chlorine					
Reserve message	after task	1-150 kg	1		
Drum size	after task	10-150 kg	1		
Reserve indication	On	Off - On			
3 Reserve indication acid					
Reserve message after	20l	1-500l	1		
Canister size	25l	1-500l	1		
Reserve indication	On	Off - On			
4 System					
Date/ time	CET / CEST	CET -12 +11			
Display brightness	80%	9 - 100%	1		
System variant	after task	with / without feed system			
5 System → Password					
End user	—	0000 – 9999	1		
Technician 1	01234	00000 – 99999	1		
6 System → Display					
Screensaver	20%	12-100%	2		
Delay screen saver	00: 05	00: 00 – 23: 59h			
Backlight	75%	24 - 100%	2		
7 System network (if available)					
IP-address	—	xxx.xxx.xx.x			
Subnetmask	—	xxx.xxx.xxx.x			
Gateway	—	xxx.xxx.xx.x			
8 Dosing performance determination					
1. Dosing sample		Weight:			
2. Dosing sample		Weight:			
3. Dosing sample		Weight:			
9 Dust extraction					
Flushing interval	12h	0 – 48h	1		
Flushing time	5 seconds	0 - 5 seconds	1		
Dust extraction	after task	Off – On			

10 Buffer tank/feed system (optional)					
Dosing performance line 1	—	Adjustment at the valve			
Dosing performance line 2	—	5-1000 l/h			
Dosing performance line 3	—	5-1000 l/h			
Dosing performance line 4	—	5-1000 l/h			
Dosing performance line 5	—	5-1000 l/h			
Dosing performance line 6	—	5-1000 l/h			
Dosing performance line 7	—	5-1000 l/h			
Adjustment pressure retention valve	1.2 barg				
11 pH Monitoring (optional)					
ON/OFF	after task	Off – On			
Setpoint	6.8 – 7.2pH				
Alarm low	6.5pH				
Alarm high	7.5pH				
Time delay	5 minutes				
Measurement internal / external	after task	Internal / external			
12 Delay Booster pump					
Delay time	20	0 - 120 sec	5		
13 Dosing performance Chlorine granulate					
RPM dosing screw	after task	12 – 60 rpm	1		
Diameter dosing screw	after task	19 / 26mm	1		
14 Dosing performance ac					
Hose diameter	4.8mm	0.8/1.6/3.2/4.8/ext			
15 Maintenance interval					
Maintenance after	365 days	0 – 365 days			

9.5 Maintenance protocol

The maintenance protocol is included with the attached documents.

9.6 Spare part list

Device part	Designation	Item no.
GRANUDOS PLUS	Maintenance set GRANUDOS 10-100 complete	12631
Chlorine dosing	Dosing hopper GR PLUS HTH 40 kg (for other chlorine drums upon request)	16775
	Cover for dosing hopper GR45 PLUS	12866
	Dosing motor PLG 30-35 GR45	11676
	Dosing motor PLG 30-60 GR100	11546
	Motor bracket PLG-d32	11542
	Dosing screw d6/D26	11550
	Dosing pipe, heated GR	11556
	Knocker, complete GR 45	11558
Acid dosing	Acid pump Sa complete	11628
	Pump housing Sa	14140
	Roller carrier Sa	12609
	Hose set Sa 4.8x1.6 Sa	13414
	Suction set GR45	12523-1
	Acid dosing valve GR	15099
	Spare part set for acid dosing valve	15764
Filter	Filter housing d75 GR PLUS	15407
	Filter top with ball valve d25	12304
	O-ring for filter d75	11258
Controller	Control plate IO_GRD_V80	26940
	Control plate NT_GRD_V80, power pack	27520
	Operating touch display 7"	27080
	Main switch	21839
	Fuse holder FPG1 5x20 IP67	21899
	Fuse set	26844
Float valve	Float valve d25 GR PLUS complete	15405
	Membrane / O-ring for float valve	16367
	Float	11621
Flushing tub	Level switch GR/PAK	10496
Booster pump GR	Booster pump Lo 1HM04-A	24618-1
	Mechanical seal Lo-A	12800-1
Flow switch	Suction pipe GR ½" S14 GR PLUS	25659
	Flow switch GR/PAK - 18x1	25671
	Connecting hose Viton - 10/2.5/180	11565-1
Injector	Injector ½" GR/PAK complete	24997
	Pinhole apertures, set	11594
Dissolving cyclone	Dissolving cyclone GR 45/100 PLUS	11613
	No chlorine switch	11609
Feed system	Activated carbon 1 kg for filter on GPL tank	12546
	Level switch in tank 1 ½" PVC/PVDF GPL	23846-1
	Feed pump MPN 130 - 1 bar	11241
	Feed pump MPN 150 - 1.5 bar	11242
	Feed pump MPN 130 PVDF FU - 1.6 bar	21983
	Non-return valve d25	11013
	Diaphragm seal d25-1/4"	10042
	Manometer 1/4 bar ¼" Glycerine	21937
	Pressure retention valve DHV DN 20	10071
	Maintenance set pressure retention valve DHV DN20	25494
	Control valve ½"-Bü	20294
	Maintenance set control valve (20294)	21416-1
	Membrane T4 DN15/20 PTFE-coated	14079
pH Monitoring	pH electrode GR PLUS	12436
	Cable for pH electrode GR PLUS	11680
Dust extraction	Solenoid valve	14040
	Pump dust extraction	17581
	Membrane solenoid valve	11829

10 Appendices

- Commissioning Protocol WDT
- Maintenance Protocol WDT
- Operating instructions for setting up the external pH monitoring

Personal notes

Commissioning Protocol IP 68 GRANUDOS 45/100 PLUS V80 Touch



This protocol is to be completed by the commissioning technician! Without a completed and signed commissioning protocol, all warranty claims become void!

Object: Date: ____.

City, street, house number:

Device type: Year of manufacture: Serial number:

	Activity	Completed	Comment
1	<u>Preparatory Tasks</u>		
1.1	Install the roller support for the peristaltic pump, see OI Chapter 5.2	<input type="checkbox"/>	
1.2	Connect the acid canister and attach the chlorine drum	<input type="checkbox"/>	
1.3	Vent the booster pump	<input type="checkbox"/>	
1.4	Fill the buffer tank	<input type="checkbox"/>	
2	<u>Dissolving Unit (observe a 6 second delay with the switches!)</u>		
2.1	Check the pressure switch: Close the inlet ball valve, GRANUDOS stops, fault display	<input type="checkbox"/>	
2.2	Adjust the water flow in the dissolving unit		
2.3	Adjust the water level - adjust the washer to the pressure conditions	<input type="checkbox"/>	
2.4	Adjust the pressure switch (41): see OI under Chapter 5.2.8	<input type="checkbox"/>	
2.5	Vent the dust extraction pump (61) (optional), output test for flushing and dust extraction drive	<input type="checkbox"/>	
2.6	Vent the feed pump for the buffer tank		
2.7	Check the flow switch: Close the outflow ball valve (53), dosing stops, fault display	<input type="checkbox"/>	
2.8	Check the level switch: Switch body up – dosing stops, fault display	<input type="checkbox"/>	
2.9	Check the level switch of the flushing tank (47): Switch body down – GR stops, fault display	<input type="checkbox"/>	
2.10	Check the function of the float valve (42) - flow reacts gently	<input type="checkbox"/>	
3	<u>Dosing Technology for Chlorine</u>		
3.1	Heating function (26): Dosing pipe warm	<input type="checkbox"/>	
3.2	Function of the chlorine empty switch (22): Turn drum - fault display	<input type="checkbox"/>	
3.3	Function of the dosing motor (29): Programme for chlorine dosing output test - chlorine is dosed	<input type="checkbox"/>	
3.4	Check the tension bands and safety belt	<input type="checkbox"/>	
3.5	Instructions for drum exchange, see operating instructions under Chapter 5.2.3	<input type="checkbox"/>	
4	<u>Dosing Technology for pH Reducer</u>		
4.1	Function of the empty switch: Suction lance pulled from the canister - fault display	<input type="checkbox"/>	
4.2	Function of the dosing pump: Programme for acid output test - pump suction	<input type="checkbox"/>	
5	<u>Controller - after opening the controller</u>		
5.1	All connector plugs: securely engaged	<input type="checkbox"/>	

Commissioning Protocol IP 68 GRANUDOS 45/100 PLUS V80 Touch



6	<u>Conveyor System</u>		
6.1	Check the feed pump: Pressure, leakage, noise, output test for feed pump (minimum pressure 1.0 bar)	<input type="checkbox"/>	
6.2	Filling - Function of the 4 level switches in the tank and 1 level switch in the collecting basin	<input type="checkbox"/>	
6.3	Check the control valves	<input type="checkbox"/>	
6.4	Check the backflow prevention in the dosing lines	<input type="checkbox"/>	
6.5	Check the backflow prevention of the filling	<input type="checkbox"/>	
6.6	Check the pressure control valve	<input type="checkbox"/>	
7	<u>Other</u>		
7.1	Clean the GRANUDOS system	<input type="checkbox"/>	
7.2	Discuss and hand over operating instructions	<input type="checkbox"/>	

Additional remarks:

Commissioning and instruction carried out by: _____

Instructed persons: _____

Signature of commissioner: _____

Operator's counter-signature: _____

Maintenance Protocol WP 74

GRANUDOS 45/100 PLUS V80 Touch

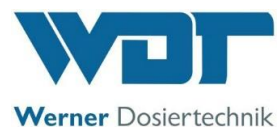

This protocol to be completed by the maintenance technician! Without a completed and signed maintenance protocol, we reserve the right to assert a warranty regulation.

Object: _____ Maintenance year: 20____

City, street, house number: _____

Device type: _____ Year of manufacture: _____ Serial number: _____

	Activity	Maintenance interval in	Month 1	Month 2	Month 3	Month 4	Month 5	Month 6	Month 7	Month 8	Month 9	Month 10	Month 11	Month 12	Comment / additional tasks
1	<u>Granudos Plus Dissolving Unit</u>														
1.1	Check the level switch min + max	6						<input type="checkbox"/>						<input type="checkbox"/>	
1.2	Check the pressure switch, adjust, if necessary	6						<input type="checkbox"/>						<input type="checkbox"/>	
1.3	Check the flow switch	6						<input type="checkbox"/>						<input type="checkbox"/>	
1.4	Renew the floating valve membrane and the conical seal	12												<input type="checkbox"/>	
1.5	Check the function of the float valve	6						<input type="checkbox"/>						<input type="checkbox"/>	
1.6	Renew the hose to the suction pipe	12												<input type="checkbox"/>	
1.7	Check the pump impeller and lid (only for Calpeda brand pumps)	12												<input type="checkbox"/>	
1.8	Mechanical seal on b-pump - check for leaks	6						<input type="checkbox"/>						<input type="checkbox"/>	
1.9	Check the pump ball bearings - noise	6						<input type="checkbox"/>						<input type="checkbox"/>	
1.10	Clean the dirt filter	3			<input type="checkbox"/>			<input type="checkbox"/>			<input type="checkbox"/>			<input type="checkbox"/>	
1.11	Replace all O-rings	12												<input type="checkbox"/>	
1.12	Diffuser nozzle diameter < 6 mm - check; (check passage with a 5.5 mm drill)	12												<input type="checkbox"/>	
2	<u>Dosing Device for Chlorine</u>														
2.1	Heating function: Dosing pipe warm	6						<input type="checkbox"/>						<input type="checkbox"/>	
2.2	Check the chlorine empty switch	6						<input type="checkbox"/>						<input type="checkbox"/>	
2.3	Check the dosing screw, clean	6						<input type="checkbox"/>						<input type="checkbox"/>	
2.4	Dosing motor: Replace the gaskets	12												<input type="checkbox"/>	
3	<u>Dosing Device for Acid</u>														
3.1	Check the peristaltic pump for function and for humidity and corrosion	1	<input type="checkbox"/>	<input type="checkbox"/>	<input type="checkbox"/>	<input type="checkbox"/>	<input type="checkbox"/>	<input type="checkbox"/>	<input type="checkbox"/>	<input type="checkbox"/>	<input type="checkbox"/>	<input type="checkbox"/>	<input type="checkbox"/>	<input type="checkbox"/>	
3.2	Empty switch function	6						<input type="checkbox"/>						<input type="checkbox"/>	
3.3	Renew dosing hose: Material Pharmed (standard)	12												<input type="checkbox"/>	
	Material Viton (for hydrochloric acid 10 - 33%)	6						<input type="checkbox"/>						<input type="checkbox"/>	
3.4	Renew gaskets of the acid dosing valve	12												<input type="checkbox"/>	
4	<u>Dust extraction (optional)</u>														
4.1	Completely check and clean the flushing ring of the suspensor, including the injector and flushing pipe	2		<input type="checkbox"/>		<input type="checkbox"/>		<input type="checkbox"/>		<input type="checkbox"/>		<input type="checkbox"/>		<input type="checkbox"/>	
4.2	Check the drill holes of the outlet connection for contamination and clean them	2		<input type="checkbox"/>		<input type="checkbox"/>		<input type="checkbox"/>		<input type="checkbox"/>		<input type="checkbox"/>		<input type="checkbox"/>	
4.3	Check / exchange the disconnect lever of the solenoid valve	12												<input type="checkbox"/>	

Maintenance Protocol WP 74

GRANUDOS 45/100 PLUS V80 Touch

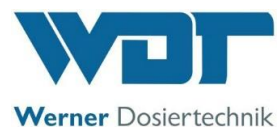

	Activity	Maintenance interval in	Month 1	Month 2	Month 3	Month 4	Month 5	Month 6	Month 7	Month 8	Month 9	Month 10	Month 11	Month 12	Comment / additional tasks
5	<u>Feed system with buffer tank (optional)</u>														
5.1	Check function of the level switch, 4x buffer tank + 1x collecting tub	6						<input type="checkbox"/>						<input type="checkbox"/>	
5.2	Check the function of the non-return valves and pressure retention valves	6						<input type="checkbox"/>						<input type="checkbox"/>	
5.3	Clean the pressure retention valve	12												<input type="checkbox"/>	
5.4	Check the function of the manometer	6						<input type="checkbox"/>						<input type="checkbox"/>	
5.5	Flush the system with water and diluted acid (clean)	12												<input type="checkbox"/>	
5.6	Check the electric control valves	12												<input type="checkbox"/>	
5.7	Renew the separating membranes of the control valves (maintenance set)	12												<input type="checkbox"/>	
5.8	Renew the membranes of the non-return valves	12												<input type="checkbox"/>	
5.9	Renew the active carbon in the filter	12												<input type="checkbox"/>	
5.10	Check the pH electrode (and calibrate it)	3		<input type="checkbox"/>				<input type="checkbox"/>			<input type="checkbox"/>			<input type="checkbox"/>	
5.11	Check the PTFE mechanical seals on the feed pump	12												<input type="checkbox"/>	
5.12	Check the feed pump's ball bearings	12												<input type="checkbox"/>	
5.13	Renew the PTFE mechanical seals on the feed pump	24												<input type="checkbox"/>	
5.14	Renew the feed pump's ball bearings	24												<input type="checkbox"/>	
5.15	Renew the membranes of the pressure-retention valves	24												<input type="checkbox"/>	
6	<u>Other Tasks</u>														
6.1	Thoroughly clean the GRANUDOS system	1	<input type="checkbox"/>	<input type="checkbox"/>	<input type="checkbox"/>	<input type="checkbox"/>	<input type="checkbox"/>	<input type="checkbox"/>	<input type="checkbox"/>	<input type="checkbox"/>	<input type="checkbox"/>	<input type="checkbox"/>	<input type="checkbox"/>	<input type="checkbox"/>	
6.2	Check dosing lines for firmness and wall thickness, renew, if necessary	12												<input type="checkbox"/>	
7	<u>Maintenance Tasks with each Drum Exchange!</u>														
7.1	Clean the dissolving pipe in case of contamination	F	<input type="checkbox"/>	<input type="checkbox"/>	<input type="checkbox"/>	<input type="checkbox"/>	<input type="checkbox"/>	<input type="checkbox"/>	<input type="checkbox"/>	<input type="checkbox"/>	<input type="checkbox"/>	<input type="checkbox"/>	<input type="checkbox"/>	<input type="checkbox"/>	
7.2	Remove encrustations from the dosing hopper	F	<input type="checkbox"/>	<input type="checkbox"/>	<input type="checkbox"/>	<input type="checkbox"/>	<input type="checkbox"/>	<input type="checkbox"/>	<input type="checkbox"/>	<input type="checkbox"/>	<input type="checkbox"/>	<input type="checkbox"/>	<input type="checkbox"/>	<input type="checkbox"/>	
7.3	Test chlorine and acid dosing	F	<input type="checkbox"/>	<input type="checkbox"/>	<input type="checkbox"/>	<input type="checkbox"/>	<input type="checkbox"/>	<input type="checkbox"/>	<input type="checkbox"/>	<input type="checkbox"/>	<input type="checkbox"/>	<input type="checkbox"/>	<input type="checkbox"/>	<input type="checkbox"/>	
7.4	Check for pump noise	F	<input type="checkbox"/>	<input type="checkbox"/>	<input type="checkbox"/>	<input type="checkbox"/>	<input type="checkbox"/>	<input type="checkbox"/>	<input type="checkbox"/>	<input type="checkbox"/>	<input type="checkbox"/>	<input type="checkbox"/>	<input type="checkbox"/>	<input type="checkbox"/>	
7.5	Check the system for leaks.	F	<input type="checkbox"/>	<input type="checkbox"/>	<input type="checkbox"/>	<input type="checkbox"/>	<input type="checkbox"/>	<input type="checkbox"/>	<input type="checkbox"/>	<input type="checkbox"/>	<input type="checkbox"/>	<input type="checkbox"/>	<input type="checkbox"/>	<input type="checkbox"/>	
7.6	Check the hoses of the dust extraction (optional) and clean, if necessary	F	<input type="checkbox"/>	<input type="checkbox"/>	<input type="checkbox"/>	<input type="checkbox"/>	<input type="checkbox"/>	<input type="checkbox"/>	<input type="checkbox"/>	<input type="checkbox"/>	<input type="checkbox"/>	<input type="checkbox"/>	<input type="checkbox"/>	<input type="checkbox"/>	

The stated interval times are manufacturer's suggestions and must be adjusted to the operating conditions, if necessary.

Additional remarks:

Maintenance performed and device functioning checked: _____ Date: _____
Signature

Operator's counter-signature: _____
Signature